

120 Vac Input

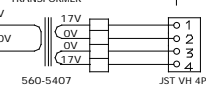

TRANSFORMER



838-13616

AUDIO POWER AMP 2CH

[Extra]

5k pot

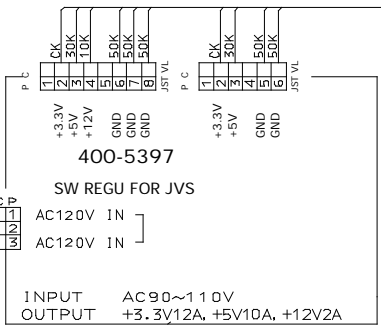
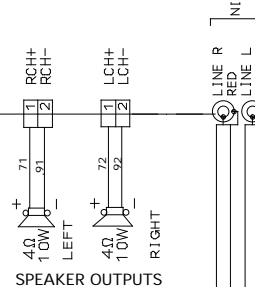
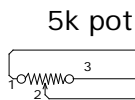

COIN COUNTER To Extra Yellow Wire

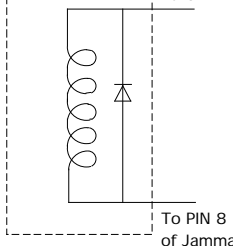

6P EDGE CONNECTOR JAMMA (P=3.96mm)

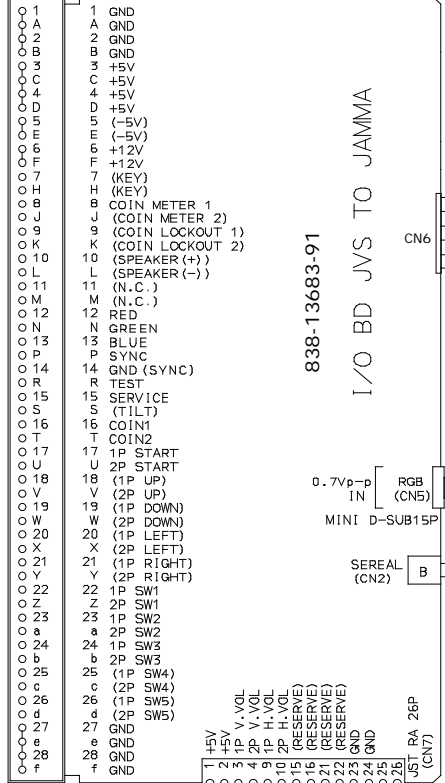

838-13683-91

I/O BD JVS TO JAMMA

CONTROL PANEL

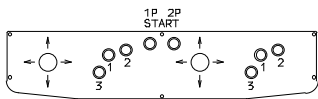

CODE	COLOR	CODE	COLOR	CODE	COLOR
10	RED	60	ORANGE	C	BROWN
20	BLUE	70	BLACK	D	PURPLE
30	YELLOW	80	GRAY	E	LIGHT GREEN
40	GREEN	A	PINK		
50	WHITE	B	SKY BLUE		

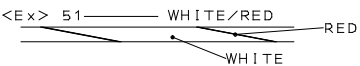

The character following the wire color code indicates the size of the wire.
 K — AWG18 UL1015
 L — AWG20 UL1007
 None — AWG22 UL1007

JAMMA CONNECTIONS USED ARE:
 * VIDEO OUT
 * SWITCH INPUTS
 * SWITCH GROUND RETURNS
 * COIN COUNTER OUTPUT

NOTE: THERE ARE TO BE NO CONNECTIONS MADE TO THE JAMMA INTERFACE OTHER THAN THE ABOVE FOREMENTIONED.

NAOMI KIT UNIVERSAL WIRING DIAGRAM (1/1)