

Assembly Instructions and General Operations Manual

2001/Rev. A

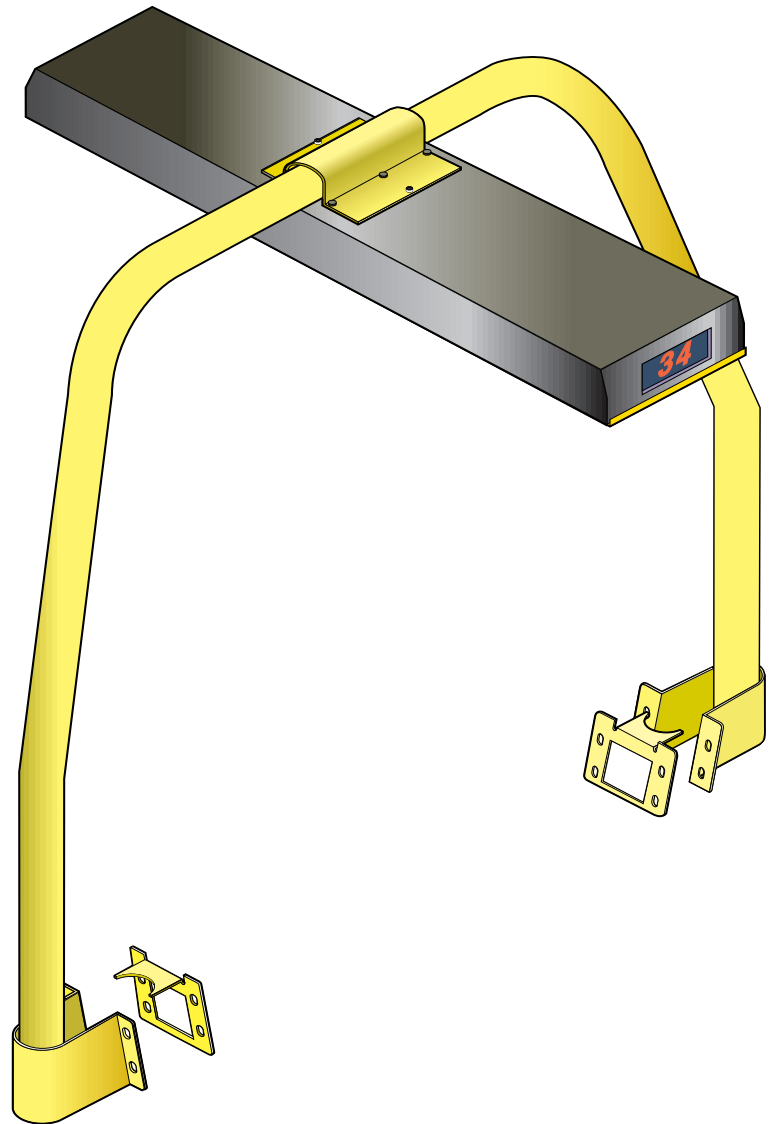

HF II 110V OVERHEAD INSTALLATION

Model No. 020400370

Valley-Dynamo, L.P.
2525 Handley Ederville Road
Richland Hills, Texas 76118

(817) 299-3070 Phone
(817) 299-3170 Fax

www.Valley-Dynamo.com
Techhelp@Valley-Dynamo.com

VALLEY • DYNAMO
VDLP
LIMITED PARTNERSHIP



Valley-Dynamo, L.P.
2525 Handley Ederville Road
Richland Hills, Texas 76118

(817) 299-3070 Phone
(817) 299-3170 Fax

www.Valley-Dynamo.com
Techhelp@Valley-Dynamo.com

No part of this publication may be reproduced by any mechanical, photographic, or electronic process, or in the form of a phonographic recording, nor be transmitted, or otherwise copied for public or private use without written consent from Valley-Dynamo, L.P.

©2001 Valley-Dynamo, L.P.
All Rights Reserved

Assembly Instructions and General Operations Manual

2001/Rev. A

HF II 110V OVERHEAD INSTALLATION

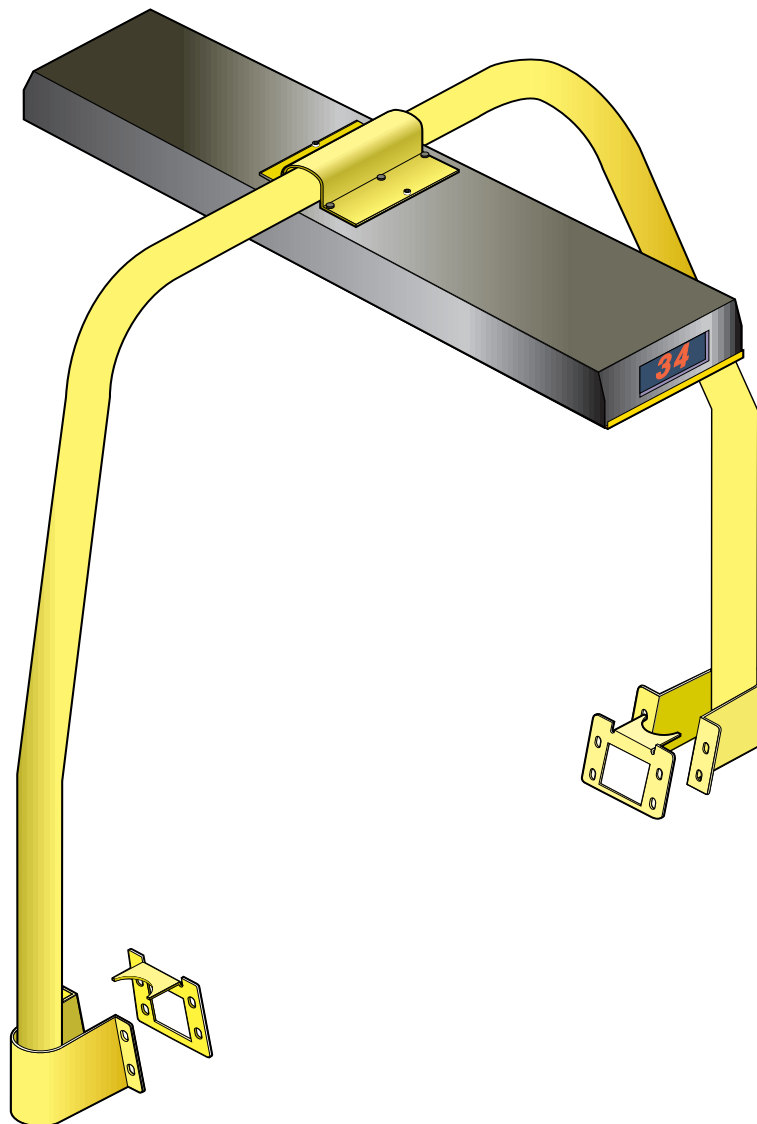

Table of Contents

Limited Warranty	05
Warranties and Notices	06
Assembly Introduction	07
Assembly Instructions	08
Overhead Kit Parts List	13
Overhead Kit Price List	14
Illustration, Overhead Mounting Brackets	15
Illustration, Fluorescent Hood Assembly	16
Illustration, Logic Board Cable Harnesses	17
Illustration, Overhead Tube Cable Routing	18
Illustration, HF II 110V Overhead Installation	19

LIMITED WARRANTY

Valley-Dynamo, L.P., a Texas Limited Partnership, having its principal place of business at 2525 Handley-Ederville Rd., Richland Hills, TX 76118 (“Manufacturer”) warrants its Coin Operated Amusement Game products (the “Products”) as follows:

1. Limited Warranty:

Manufacturer warrants that the Products sold hereunder will be free from defects in material and workmanship for a period of ninety (90) days from the date of purchase. If the Products do not conform to this Limited Warranty during the warranty period (as herein above specified), Buyer shall notify Manufacturer in writing of the claimed defects and demonstrate to Manufacturer satisfaction that said defects are covered by this Limited Warranty. If the defects are properly reported to Manufacturer within the warranty period, and the defects are of such type and nature as to be covered by this warranty, Manufacturer shall, at its own expense, furnish, replacement Products or, at Manufacturer’s option, replacement parts for the defective Products. Shipping and installation of the replacement Products or replacement parts shall be at Buyer’s expense.

2. Other Limits:

THE FOREGOING IS IN LIEU OF ALL OTHER WARRANTIES, EXPRESS OR IMPLIED, INCLUDING BUT NOT LIMITED TO THE IMPLIED WARRANTIES OF MERCHANTABILITY AND FITNESS FOR A PARTICULAR PURPOSE. Manufacturer does not warrant against damages or defects arising out of improper or abnormal use of handling of the Products; against defects or damages arising from improper installation (where installation is by persons other than Manufacturer), against defects in products or components not manufactured by Manufacturer, or against damages resulting from such non-Manufacturer made products or components. Manufacturer passes on to Buyer the warranty it received (if any) from the maker thereof of such non-Manufacturer made products or components. This warranty also does not apply to Products upon which repairs have been effected or attempted by persons other than pursuant to written authorization by Manufacturer.

3. Exclusive Obligation:

THIS WARRANTY IS EXCLUSIVE. The sole and exclusive obligation of Manufacturer shall be to repair or replace the defective Products in the manner and for the period provided above. Manufacturer shall not have any other obligation with respect to the Products or any part thereof, whether based on contract, tort, strict liability or otherwise. Under no circumstances, whether based on this Limited Warranty or otherwise, shall Manufacturer be liable for incidental, special, or consequential damages.

4. Other Statements:

Manufacturer's employees or representatives' ORAL OR OTHER WRITTEN STATEMENTS DO NOT CONSTITUTE WARRANTIES, shall not be relied upon by Buyer, and are not a part of the contract for sale or this limited warranty.

5. Entire Obligation:

This Limited Warranty states the entire obligation of Manufacturer with respect to the Products. If any part of this Limited Warranty is determined to be void or illegal, the remainder shall remain in full force and effect.

WARNINGS AND NOTICES

USE OF NON-VALLEY-DYNAMO, L.P. PARTS OR CIRCUIT MODIFICATIONS MAY CAUSE SERIOUS INJURY OR EQUIPMENT DAMAGE! USE ONLY GENUINE VALLEY-DYNAMO, L.P. AUTHORIZED PARTS.

- For safety and reliability, substitute parts and modifications are not recommended.
- Substitute parts or modifications may void FCC type acceptance.
- Use only authorized components and parts. Failure to do so will void warranty and may result in incorrect and/or unsafe operation.

NOTICE

Information in this manual is subject to change without notice. Valley-Dynamo, L.P. reserves the right to make improvements in the equipment function, design or components as process in the engineering or manufacturing methods may warrant.

*FOR GENUINE VALLEY-DYNAMO, L.P. PARTS AND SERVICE CONTACT
YOUR LOCAL AUTHORIZED VALLEY-DYNAMO, L.P. DISTRIBUTOR.*

HF II 110V OVERHEAD INSTALLATION

The HF II 110V Model No. 020400370 Overhead Installation is delivered in one large packing container. When you receive your unit, please check the packing list affixed to the interior of the box and verify that the parts and components listed match the Overhead Kit Parts List located on Page 13 of this manual.

Before assembly begins, locate the Hardware Kit (see Page 13) and confirm that all of the necessary fasteners and related parts are included.

If you find that any of the required parts are missing, please call the dealer where you originally purchased the unit and obtain the missing components prior to assembly.

For this installation/assembly Valley–Dynamo, L.P. recommends that you have a socket wrench, 7/16" socket, Phillips screwdriver, Pliers (regular or needle nose), and a 1/8" Allen Wrench (please see page 13 for a complete recommended tools list).

HINTS



There are a number of drawings included with this assembly manual (please reference pages 15, 16, 17, 18, and 19 or the table of contents) to aid in the assembly of your HF II 110 Overhead Installation. Please refer to Page 13 to consult the Overhead Kit Parts List; including the Parts List, Hardware Kit, and Recommended Assembly Tools lists.

Before assembly begins, remove all parts from the packing box and arrange them on your work surface for easy access. To ease assembly, be sure and have all of the tools you need before beginning.

Assembly Instructions

1. Connect the Tube Overhead Female End (Part No. 800404705) to the Tube Overhead Male End (Part No. 800404700).
2. Place a Side-Mounting Bracket (Part No. 800404726) on the bottom of the Tube Overhead Male End (Part No. 800404700) and secure it with a 1/4" – 20 × 1 Hex Head Bolt (Part No. 870007306) and 1/4" Flat Washer (Part No. 870059105). DO NOT TIGHTEN THIS BOLT. Be sure to tighten it only enough to hold the bracket in place.
3. Attach the Mounting Bracket Clamp (Part No. 800404750) and the remaining Side-Mounting Bracket (Part No. 800404726) to the front side of the table using the four (4) Pan Head Phillips Screws (Part No. 870012307) and Flat Washers (Part No. 870060105) that are already attached to the table.
4. From the opposite side of the table, remove four (4) Pan Head Phillips Screws (Part No. 870012307) and Flat Washers (Part No. 870060105) that are already attached and save them for re-attachment in Step Number 13.
5. Remove the paper from the Rubber Gasket (Part No. 900400100) supplied in the Hardware Kit and peel it back to expose the adhesive backing. With the adhesive side down, carefully center the rubber mat over the joint where the Overhead Female End (Part No. 800404705) and Tube Overhead Male End (Part No. 800404700) come together and wrap it around them.
6. Remove the Light Diffuser (Part No. 800404735) from the Light Hood Overhead Housing (Part No. 800404710) and carefully remove the fluorescent bulbs, one at a time. Before proceeding to step five (5), place both bulbs in a safe area where they will not be disturbed while you continue with the rest of the assembly.
7. Take the Light Housing Mounting bracket (Part No. 800404720) and place it on the

floor with the studs facing up (it's preferable that you use a sheet of cardboard or a blanket between the bracket and the floor to protect it from scratches).

8. Position both the Tube Overhead Female End (Part No. 800404705) and the Tube Overhead Male End (Part No. 800404700) in the Light Housing Mounting Bracket (Part No. 800404720). Center the tube ends in the bracket. Turn over the Overhead Housing (Part No. 800404710) and place it upside down, guiding the six (6) Mounting Bracket studs through the holes on the hood.
9. Place one 1/4" Flat Washer (Part No. 870059105) over each of the studs and thread a 1/4" – 20 Kep Nut (Part No. 870052105) onto each stud. Tighten these nuts by hand to secure the Overhead Housing. Then, use a 7/16" socket wrench and tighten each nut two full rotations in an "X" pattern.
10. Rotate the assembled Overhead unit—now with the Overhead Light Hood Housing (Part No. 800404710) securely installed—into the upright position.
11. Cut the wire tie that is holding the excess Wire Harness, Overhead (Part No. 730400250) and feed the wires through the Overhead Light Hood Housing (Part No. 800404710) into the Tube Overhead Male End (Part No. 800404700). Once the wires are pushed through the tube and reach the opening at the bottom, you may have to use needle nose pliers to pull them completely through the hole at the bottom (on the inside side of the tube).
12. Cut the wire tie that is currently holding the Side-Mount Score Display Extension Wire Harness (Part No. 730408400) in place and feed the harness into the table.
13. Place the remaining four 1/4" – 20 × 1 Black Pan Head Phillips Screws (Part No. 870012307) and the remaining Mounting Bracket Clamp (Part No. 800404750) by the center of the backside on the table.
14. Remove the trap door from the bottom of the table.

15. Using TWO people, carefully carry the assembled Overhead unit to the table—with the Tube Overhead Male End (Part No. 800404700) oriented so that the wires exit out from the backside of the table. Lower the Tube Overhead Female End (Part No. 800404705) into the Side-Mounting Bracket (Part No. 800404726) and Mounting Bracket Clamp (Part No. 800404750).
16. While one person holds up the Male Tube side of the Overhead Assembly, have the other person feed the wires through the opening in the Mounting Bracket Clamp (Part No. 800404750) and then through the hole on the side of the table.
17. Once the parts are positioned, your helper should use the four (4) 1/4" – 20 x 1 Phillip head screws to attach the Side-Mounting Bracket (Part No. 800404726) and Mounting Bracket Clamp (Part No. 800404750) to the table.
18. On both sides of the table, tighten the Side-Mounting Brackets (Part No. 800404726) until securely fastened.
19. Then, use the last 1/4" – 20 hex head bolt and secure the Tube Overhead Female End (Part No. 800404705) to the Mounting Bracket Clamp (Part No. 800404750). AT THIS TIME, TIGHTEN BOTH SIDES FIRMLY with a 7/16" socket.
20. Use a level or your best visual judgement to adjust the Overhead Housing (Part No. 800404710) until it is level.
21. Tighten the six (6) Nuts on the Light Housing Mounting Bracket (Part No. 800404720) with a 7/16" socket wrench. Using an "X" pattern, tighten these nuts as much as possible WITHOUT stripping the threads.
22. Use a 1/8" Allen wrench and insert the 1/4" – 20 x 1/2" Allen Socket Set Screw (Part No. 870000303) into the center hole of the Overhead Housing (Part No. 800404710). This will prevent the Light Hood from any unnecessary movement.

 Please note: the hood will pivot on the tubes if pulled down or pushed up. This is normal and has been designed to function accordingly. The primary reason for this design scheme is to prevent both the Overhead Assembly and the table from damage due to players attempting to stand on them. Warning: The wiring could be damaged with excessive pivoting.

23. From the trap door, disconnect the existing 6" Wire Harness, Side-Mount Score Display Extension (Part No. 730408400) from the Wire Harness, Main Deluxe Score Display (Part No. 730408300) and attach the three (3) white connectors from the Overhead to the three (3) connectors on the main harness.

 Please Note: Do not worry about mating up the connectors incorrectly. To simplify the installation, each section will connect only one way.

24. At this time, retrieve the fluorescent tubes and install them in their Fluorescent Sockets (Part No. 880400200). First, line up one of the tubes so that the pins on each end are oriented in a straight, vertical line.

Then, lift up the tube and make sure both ends are inserted into the white sockets on each end. Once the contact pins are pushed in as far as they can go, turn the bulb clockwise one-half a turn. At this time, you should feel the tube snap into place. Be sure to check both ends and make sure the fluorescent tube is secure before you release the bulb. Repeat this process for the second bulb.

25. Apply electrical power to the table. At this time, both of the bulbs should illuminate. If one (or both) do not light up—attempt to adjust the bulbs by rotating them clockwise to counter-clockwise until a good connection is made.
26. If the bulbs still do not illuminate, inspect the Bulb Mounting Brackets (Part No. 800404730) to make sure they line up flush and square to the bulbs. If they are not adjusted correctly, loosen the screws on one Bulb Mounting Bracket (Part No.

800404730) and reposition the bracket. Then, re-tighten the nuts that hold it in place. Repeat this step for the remaining three (3) brackets as needed.

27. Once the lamps are fully operational, replace the Light Diffuser (Part No. 800404735) by sliding it back into place.

28. On the left end of the Light Hood Overhead Housing (Part No. 800404710), place one (1) Diffuser Trim Bracket (Part No. 800404715) on the bottom side—with the lip facing up—and secure it to the housing using two (2) of the 8 – 32 × 5/8" Black Oxide Pan Head Phillips Self-Tapping Screws (Part No. 870000124). Repeat this step for the right end of the Light Hood Overhead Housing (Part No. 800404710).

Overhead Kit Parts List:

Parts List:		
<i>Qty.</i>	<i>Description</i>	<i>Part Number</i>
1	Housing, Overhead (Light Hood)	800404710
1	Mounting Bracket, Light Housing	800404720
1	Diffuser, Light	800404735
2	Bracket, Diffuser (Trim Brackets)	800404715
1	Tube, Overhead Male End	800404700
1	Tube, Overhead Female End	800404705
2	Mounting Bracket, Side	800404726
2	Mounting Bracket, Clamp	800404750
2	Mounting Bracket, Bulb	800404730
1	Wire Harness, Side-Mount Score Display Extension	730408400
1	Wire Harness, Main Deluxe Score Display	730408300
2	Socket Fluorescent w/Hardware	880400200
1	Wire Harness, Overhead	730400250
1	Ballast, 110V, 60 HZ	880400100
1	Board LED OSU/Score Display	880403101
1	Logic Board 7.01	880400125

Hardware Kit:		
<i>Qty.</i>	<i>Description</i>	<i>Part Number</i>
6	1/4" – 20 Kep Nuts	870052105
8	1/4" Flat Washers (Supplied on Table)	870060105
8	1/4" Washers (Supplied on Table)	870048105
2	1/4" Flat Washers (In Kit)	870059105
2	1/4" – 20 × 1" Hex HD Bolt	870007306
1	1/4" – 20 × 1" Socket (Allen) Set Screw with cup point	870000303
4	8 – 32" × 5/8" Pan Head Phillips Self-Tapping Screw, Blk. Oxide	870000124
8	1/4" – 20 × 1" Pan Head Phillips Screw, Blk. (Supplied on Table)	870012307
1	Rubber Gasket	900400100
1	Dynamo Hockey Overhead Kit Assembly Instructions	850404370

Recommended Assembly Tools:

1	Socket Wrench
1	7/16" socket
1	Phillips Screwdriver
1	Pliers, regular or needle nose
1	1/8" Allen Wrench

Overhead Kit Parts Price List:

<i>Part Number</i>	<i>Description</i>
800404710	Housing, Overhead (Light Hood)
800404700	Tube, Overhead Male End
800404705	Tube, Overhead Female End
800404715	Bracket, Diffuser
800404720	Mounting Bracket, Light Housing
800404735	Diffuser, Light
800404750	Clamp, Mounting Bracket
900400100	Rubber Sheet
870048105	1/4" Washer (Supplied on Table)
870052105	1/4" – 20 Kep Nut
870060105	1/4" Flat Washer (Supplied on Table)
870059105	1/4" Flat Washer (In Kit)
870007306	1/4" – 20 × 1" Hex HD Bolt
870000303	1/4" – 20 × 1" Socket (Allen) Set Screw With Cup Point
870000124	8 – 32" × 5/8" Pan Head Phillips Self-Tapping Screw, Black Oxide
870012307	1/4" – 20 × 1" Pan Head Phillips Screw, Black (Supplied on Table)
850404370	Dynamo Hockey Overhead Kit Assembly Instructions
800404726	Mounting Bracket, Side (w/Out Studs)
880400100	Ballast, 110 Volts, 60 HZ
730408400	Wire Harness, Side-Mount Display Extension
730408300	Wire Harness, Main Deluxe Score Display
880400200	Socket Fluorescent w/Hardware
800404730	Mounting Bracket, Bulb
730400250	Wire Harness, Overhead
880403101	Board LED OSU/Score Display
880400125	Logic Board 7.01

Illustration, Overhead Mounting Brackets

ITEM NO:	PART NUMBER:	PART DESCRIPTION:
1	800404720	MOUNTING BRACKET, LIGHT HOUSING
2	800404700	TUBE, OVERHEAD MALE END FLUORESCENT
3	800404705	TUBE, OVERHEAD FEMALE END FLUORESCENT
4	800404750	CLAMP, MOUNTING BRACKET
5	800404726	MOUNTING BRACKET, SIDE (W/OUT STUDS)
6	870048105	WASHER, 1/4" ZN
7	870012307	SCREW, BLACK, PAN HEAD PHILLIPS 1/4" - 20 x 1"

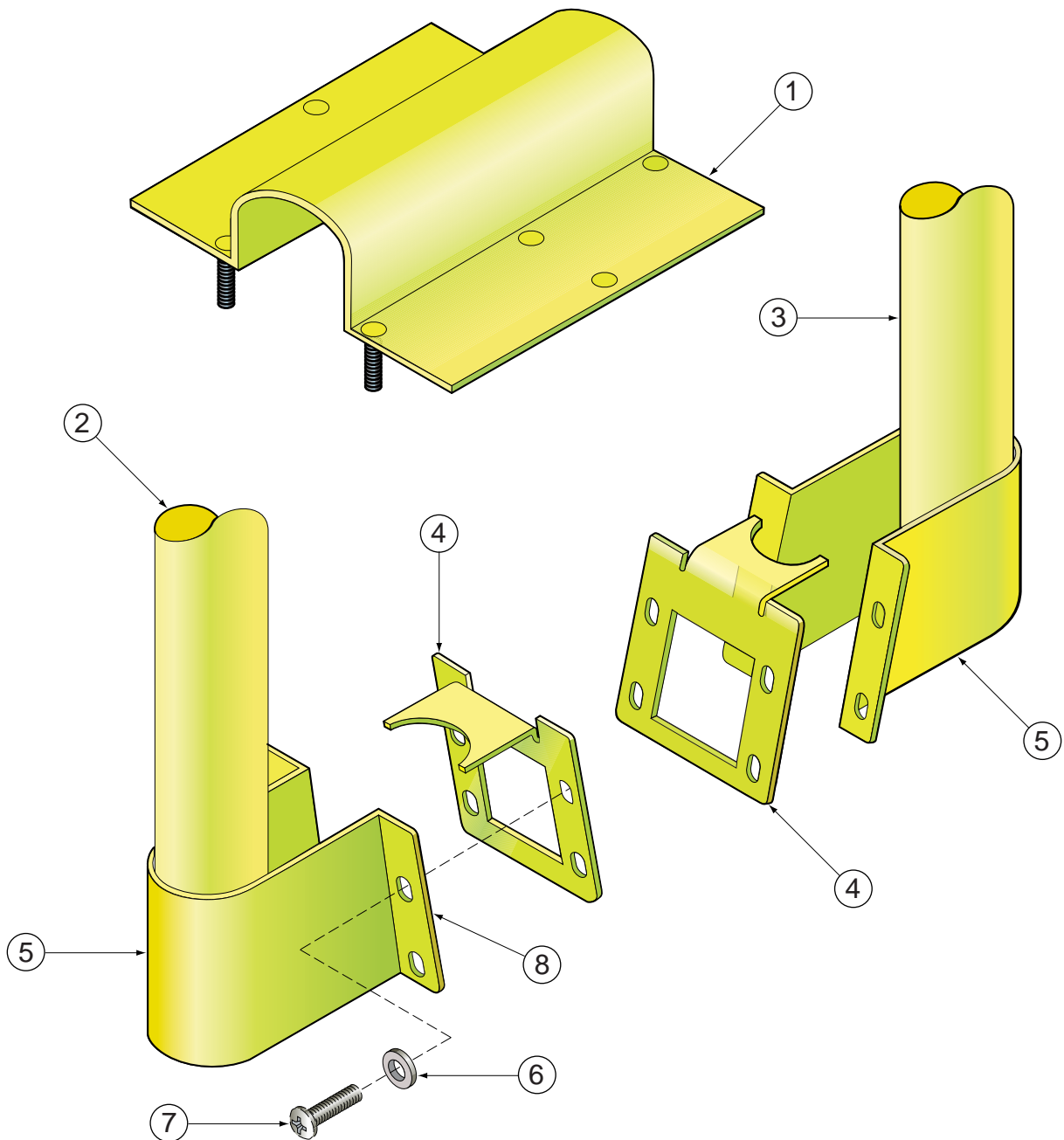

Illustration, Fluorescent Hood Assembly

ITEM NO:	PART NUMBER:	PART DESCRIPTION:
1	880400100	BALLAST, 110 VOLTS, 60 HZ
2	880400200	SOCKET FLUORESCENT W/HARDWARE
3	800404730	MOUNTING BRACKET, BULB
4	800404710	HOUSING, OVERHEAD (LIGHT HOOD)
5	880403101	BOARD LED OSU

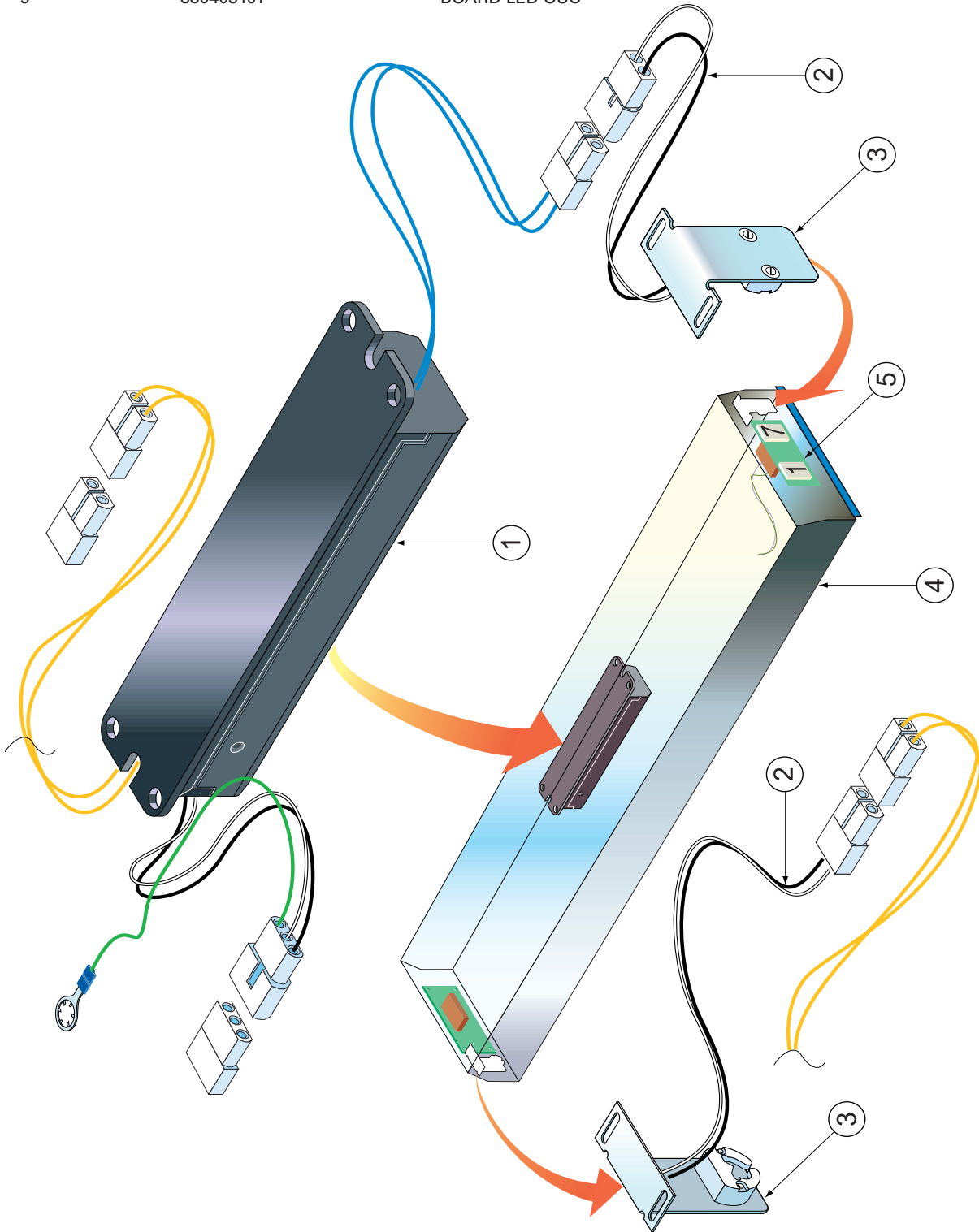

Illustration, Logic Cable Harnesses

ITEM NO:	PART NUMBER:	PART DESCRIPTION:
1	880400125	LOGIC BOARD 7.01
2	730408300	WIRE HARNESS, MAIN DELUXE SCORE DISPLAY
3	730408400	WIRE HARNESS, SIDE-MOUNT SCORE DISPLAY EXTENSION

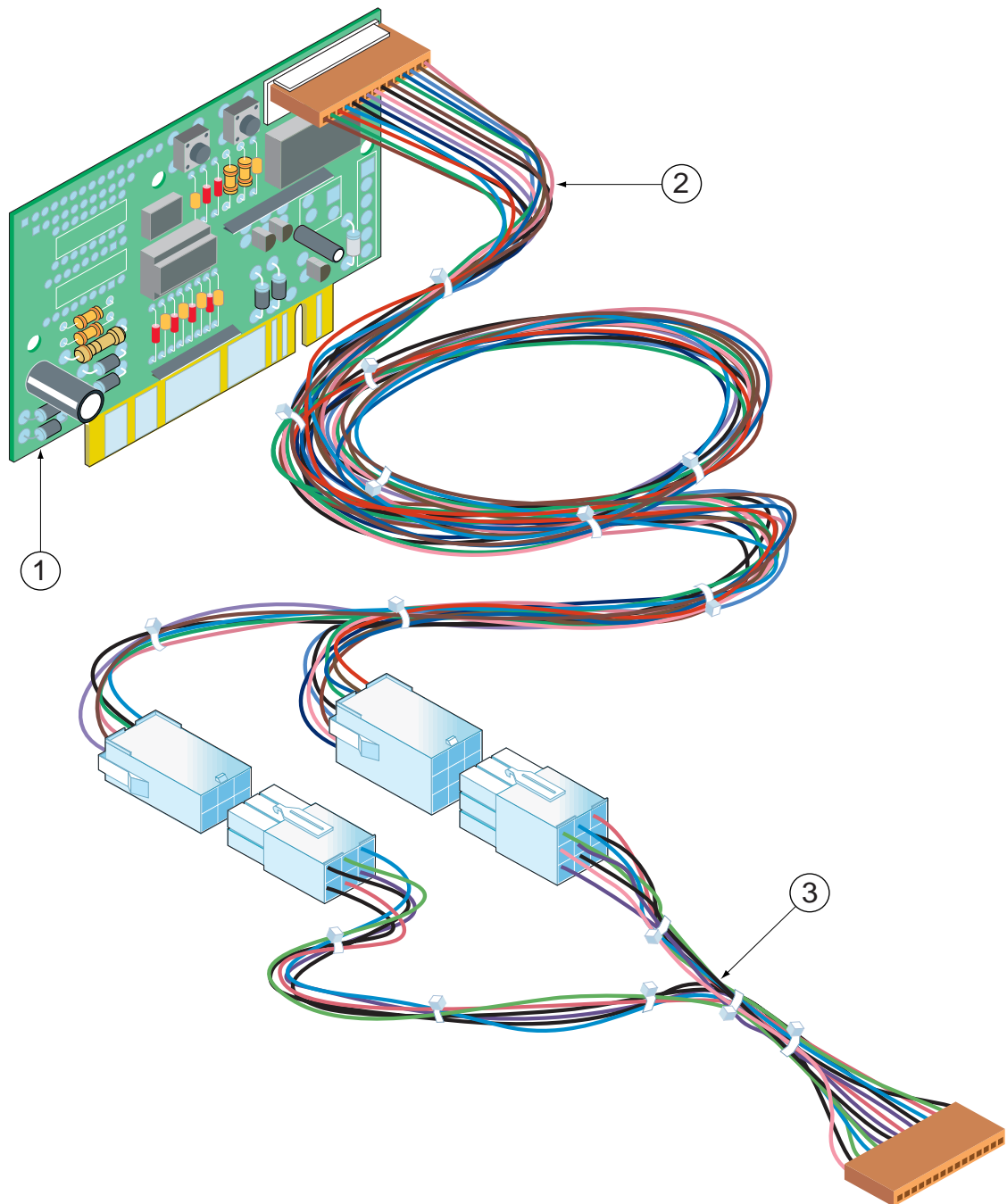

Illustration, Overhead Tube Cable Routing

ITEM NO:	PART NUMBER:	PART DESCRIPTION:
1	730400250	WIRE HARNESS, OVERHEAD
2	800404700	TUBE, OVERHEAD MALE END FLUORESCENT

