



T3.

Parts List



Door Assembly	T3.2
Cabinet Assembly	T3.3
CPU Assembly	T3.4
Dart Head Assembly	T3.5
Junction Box Assembly	T3.6



Door Assembly 40721

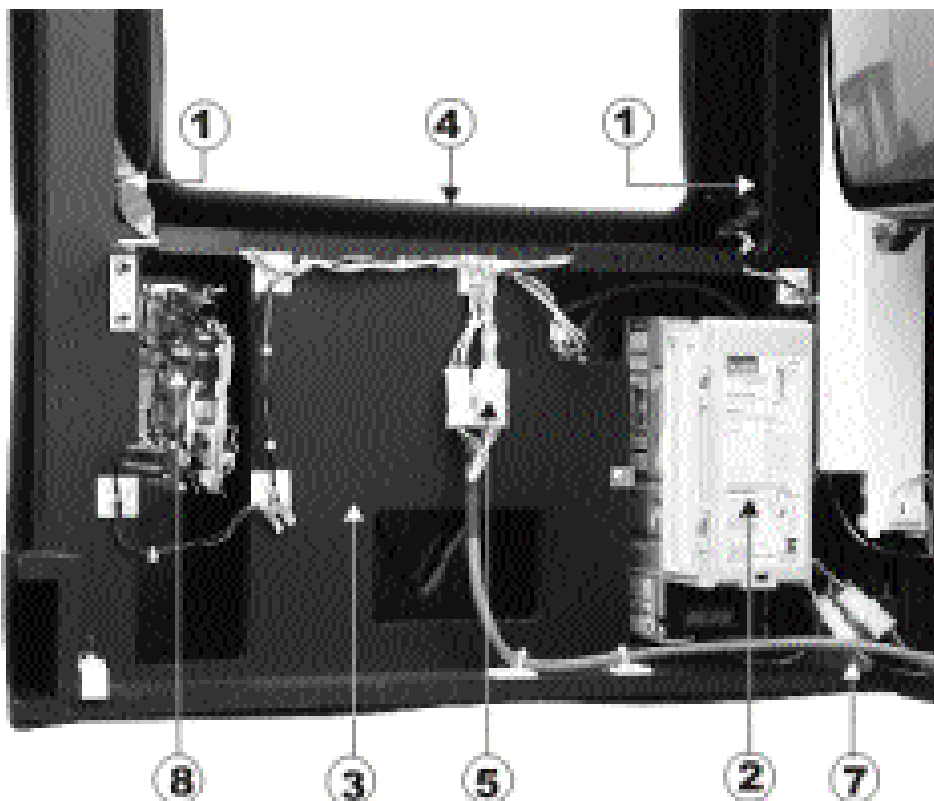

Item	Part #	Description
1	40264	6-Button Membrane Switch (2)
2	40384	Bill Acceptor
3	40717	Door Assembly - Wood Frame
4	40718	Door Bezel
5	40753	Main Door Wiring Harness
6	40779	Black Widow Emblem (Not shown)
7	41027	Pivot HInge (2)
8	40151	Coin Mechanism - Complete



Cabinet Assembly 40885

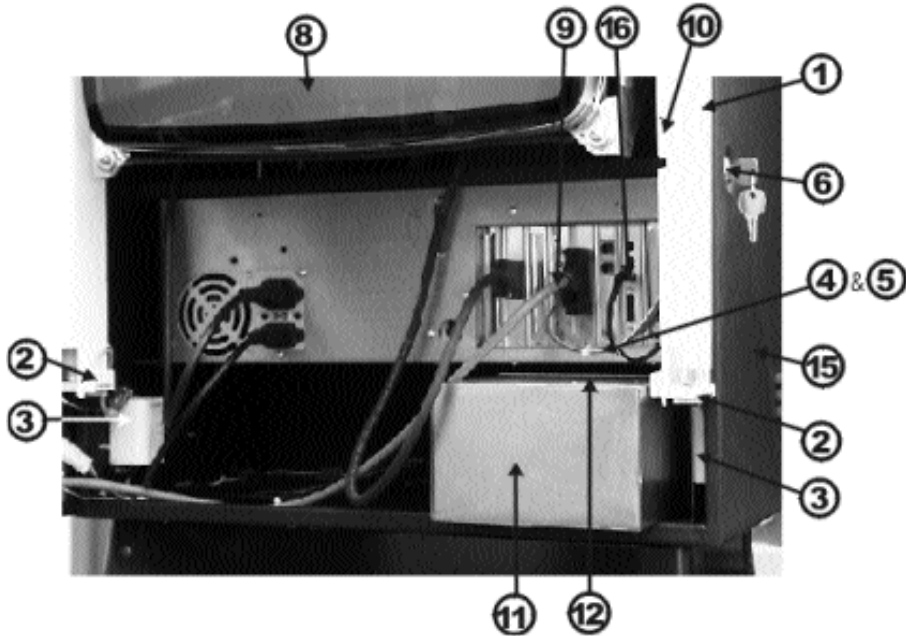

Item	Part #	Description
1	21480	Fluorescent Lamp (2)
2	27004	Lamp Socket (4)
3	32739	Fluorescent Ballast (2)
4	33761	Target Interface Cable - 30"
5	34871	Target Interface Cable - 57"
6	37664	Lock Assembly
7	40734	Z-Bracket - Wall Mount
8	40749	19" VGA Color Monitor
9	40751	Wiring Harness, IOB to Door Harness
10	40880	Lamp Reflector (2)
11	40970	Coin Box
12	40976	Coin Box Lid Assembly
13	41050	4" Speaker - 2 ohm (2)
14	41060	Wiring Harness - Missed Dart Detector (2)
15	41066	Metal Cabinet
16	41069	Wiring Harness - Speakers
17	38596	12' Power Cable - USA
18	40158	Target Interface Card (2)
	41181	Optional Base (Shown on front cover)

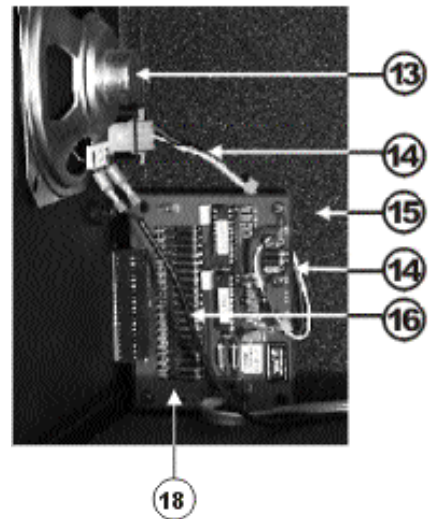

CPU Assembly 40716

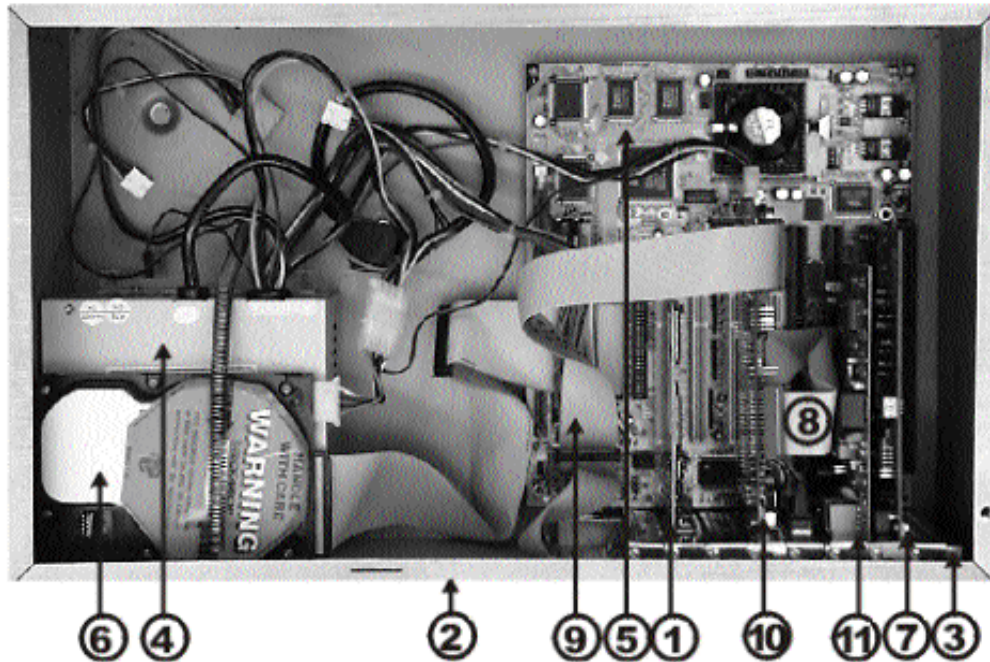

Item	Part #	Description
1	14991	Video Card
2	40123	CPU Case
3	40307	Card Slot Bracket
4	40124	Power Supply
5	40852	Pentium Motherboard
6	41300	Internal Hard Drive (Programmed)
7	40719	Sound Card
8	40758	IOB to Chassis Out Harness
9	40852	IOB to Motherboard to Portable Drive Harness
10	41252	IOB Card
	40290	IOB IC Programmed
11	40132	Modem (Optional)
	41233	Network Interface Card (Optional)



Dart Head Assembly 40723-Left 40724-Right

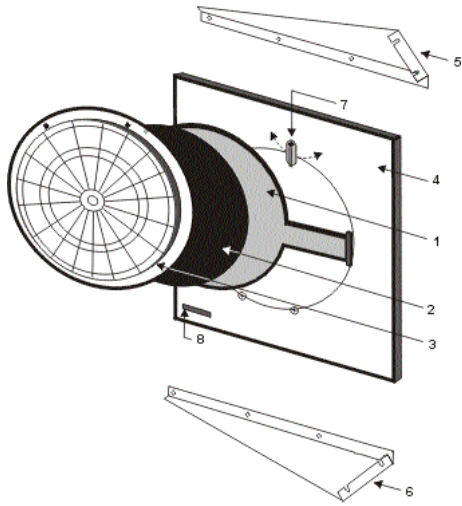

Item	Part #	Description
1	12575	Switch Matrix
2	28258	Matrix Cushion
3	37376	Spider and Segments
4	40741	Target Back
5	40742	Bracket - Upper Left - Bottom Right
6	40743	Bracket - Bottom Left - Upper Right
7		Spacer/Latch Assembly (5) (See diagram below)
8	40774	Missed Dart Detector Assembly
	40757	Catch Web (Not shown)
	41046	Matrix Shield (Not shown)

Spacer/Latch Assembly

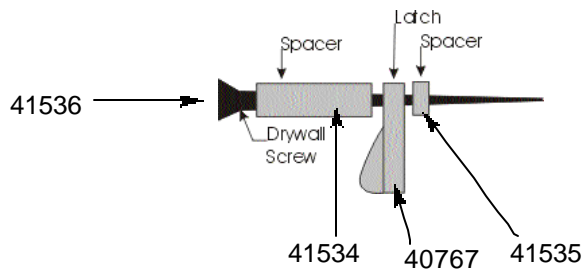

Junction Box Assembly 40920

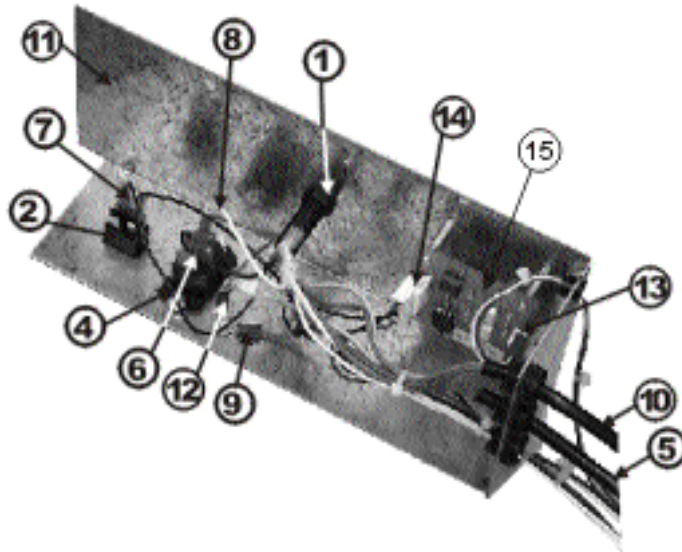

Item	Part #	Description
1	19167	Fuse Holder
2	21462	Rocker Switch
3	37003	Fuse - 4 amp, 250v, Slow Blow, 3AG
4	38463	IEC Power Inlet Socket
5	40804	14" Switch Box Power Cable
6	40806	3" Power Jumper Harness (Black)
7	40807	5" Fuse Jumper Harness (Black)
8	40808	6" Neutral Jumper Harness (White)
9	40809	4" Ground Jumper Harness (Green)
10	40812	31" Female Power Cable
11	40918	Metal Junction Box
12	41045	Jumper Harness, Inlet to Ground
13	41049	Lamp Control Harness
14	41052	Triac Power Harness
15	40705	Dual Triac Assembly