

Choppy Wood™ Operator's Manual

040-00055-01 Rev. A



Choppy Wood™

Choppy Wood™

Table of Contents

Safety	5
Operation	5
Transporting.....	5
Handling Components	5
Disconnect Power	5
Grounding	5
Electrical Shocks.....	5
Power Cord	5
Surge Suppressor	5
Water and Other Liquid Sources.....	5
Connectors	6
Computer	6
Hazard to Epileptics	6
Manual	6
Specifications	6
Product Specification	7
Electrical Power	7
Cabinet Dimensions	7
Operating Temperature	7
Operating Humidity	7
Fuse Replacement Guide	7
RIO.....	7
Game Lighting	7
Setup	8
Unpack Materials	8
Check Electrical Settings	8
Cabinet Assembly Instructions.....	9
Startup Game	9
Diagnostics and Adjustment	10

Choppy Wood™

Basic Functional Test on Initial Power Up.....	10
Test Menus.....	11
Main Menu.....	11
Diagnostics	11
Pricing.....	12
Payout Settings	13
Resets.....	15
Utilities	15
Volume.....	16
Advanced.....	17
Keys to Maximizing Earnings and Collections	18
Card Swipe Locations	18
E-Ticket Locations	18
Coin Locations	18
2 Point Ticket Locations	18
More Tickets = More Fun = Better Earnings	19
Choose Mode of Play Best Suited for Your Location	19
PC Hardware	20
Fujitsu Mini BIOS.....	20
Dell Inspiron 3050 BIOS	21
PC Hard Drive Recovery	22
Troubleshooting.....	23
Electrical and Mechanical Illustrations	27

Choppy Wood™

Safety

Operation

Before operating game, read this manual. Failure to properly install and operate this game could result in malfunction or accident. Operate the game in accordance with the manual.

Transporting

The cabinet is very heavy. Because the monitor is high, the cabinet is also very top-heavy. Use appropriate care when moving or transporting cabinet. It contains fragile glass and electronic components. Avoid rough handling.

Handling Components

Many components are extremely sensitive to handling, environmental and Electrostatic Discharge (ESD) events—especially the computer. Do not handle it roughly. Before servicing, call your distributor and inquire about the PC warranty. Use proper ESD procedures when servicing. Protect components from harmful environmental conditions, such as extreme temperatures, excessive moisture or other damaging effects.

Disconnect Power

Always turn the power off and unplug the unit before servicing or making adjustments unless otherwise instructed. Installing or repairing components while power is on can damage the components and void the warranty.

Grounding

Avoid electrical shock. Do not plug in AC power until you have inspected and properly grounded the unit. Only plug into a grounded, three-wire outlet. Do not use a “cheater” plug or cut off the ground pin on the line cord.

Electrical Shocks

There is no isolation transformer in the cabinet. Disconnect AC power before servicing. However, be aware that lethal voltages can remain in the electronic components even when AC power is disconnected. Use extreme caution when servicing. Verify that there is a working ground connection. If the unit sustains water damage, cease using it immediately and unplug AC power.

Power Cord

If the power cord is damaged or lost, replace it with an identical cord as supplied by the manufacturer or an authorized service agent.

Surge Suppressor

It is recommended that you plug your game’s power cord into a surge suppressor to help protect from power surges that may damage sensitive electronic components.

Water and Other Liquid Sources

Do not install game near sprinkler or other water jet sources. Do not use water jet to clean game. Keep minimum clearance behind game and wall for proper ventilation but also prevent access of liquid from spills and sprays from entering ventilation holes.

Choppy Wood™

Connectors

When servicing machine, ensure all connectors mate properly. If connectors do not slip in easily, do not force them. Connectors are often keyed and only connect one way. Check for correct orientation.

Computer

The computer contains sensitive components, including a hard drive. Do not handle it roughly. Call your distributor before servicing its internal components. Ask about warranty information as it relates to the PC.

Do not turn the PC power switch on or off. It should remain permanently in the ON position.

Cycle AC power on or off with the cabinet power switch.

A dongle has been inserted into one of the USB ports. This is required for game play.

Do not remove the dongle except for troubleshooting purposes.

Hazard to Epileptics

A small portion of the population has an epileptic condition that may cause seizures. Affected persons experience seizures while watching some television pictures or playing certain video games. People who have not had seizures may still have an undetected epileptic condition. If anyone in your family has experienced epilepsy symptoms (seizures or loss of awareness), consult your physician before using video games. While children play video games, a parent should observe. Be alert to the following symptoms: dizziness, altered vision, eye or muscle twitching, involuntary movements, loss of awareness, disorientation or convulsions. If you or your child experiences these symptoms, discontinue use immediately and consult your physician.

Manual

Keep this manual available and ready for use. If the game fails to function properly, turn off the machine and unplug the AC line cord. Contact your local distributor. Your warranty, when applicable, lasts 60 days from your purchase date. You may not reproduce this document or any of its contents without written authorization from Raw Thrills, Inc.

Specifications

For reasons, such as performance, this product's specifications may change without notice. Federal patent, copyright and other intellectual property laws protect the content, devices and design of the game and its equipment.

Choppy Wood™

Product Specification

Electrical Power

United States, International and Japan
Operating AC Current: 5/2.5 Amps
Voltage: 115/230 ~ VAC 50/60Hz
Inrush AC Current: 5 Amps

Cabinet Dimensions

Height: 106.5" (2.71 meters)
Width: 31.75" (0.81 meters)
Depth: 41.0" (1.04 meters)

Operating Temperature

50° F to 104° F
(10° C to 40° C)

Operating Humidity

Must not exceed 95% relative humidity.

Fuse Replacement Guide

NOTE: FOR CONTINUED PROTECTION AGAINST
FIRE AND ELECTRICAL DAMAGE, USE ONLY
SPECIFIED FUSE TYPE AND VALUE.

RIO

5VDC = 3A 250V SLO-BLO
12VDC = 5A 250V SLO-BLO

Game Lighting

5A 250V SLO-BLO (x4)

Choppy Wood™

Setup

Unpack Materials

1. Place the shipping crate on a flat, stable surface.
2. Cut the banding straps and remove the cardboard lid.
3. Lift off the large cardboard containers surrounding the cabinet assembly and remove any shipping cleats.
4. Remove the coin door key from the coin return slot.
5. Open the top coin door.
6. Locate the keys for the back doors and the cash box door.
7. Open the cash box door and remove the cash box.
8. Check for shipping damage to the following:
 - Marquee and monitor
 - Cabinet decals
9. Check the AC line cord for visible signs of damage.
Pay particular attention to the plug and line cord insulation.

Check Electrical Settings

1. Verify the voltage in the nearest AC outlet.
2. Verify the AC outlet ground connection is present and working.

Choppy Wood™

Cabinet Assembly Instructions

1. Place cabinet in desired floor location. Setup a ladder next to the cabinet for marquee installation.
2. Locate the marquee assembly as well as the following hardware: (7) black tamper proof Torx machine screws, ¼-20 thread, 3/4" long, and (7) ¼" black split lock washers, and (7) ¼" black flat washers.
3. Using a T-27 bit, securely mount the marquee assembly to the top panel of the cabinet as shown in the assembly setup diagram, avoiding any pinching/crushing of the wire harness in the process.

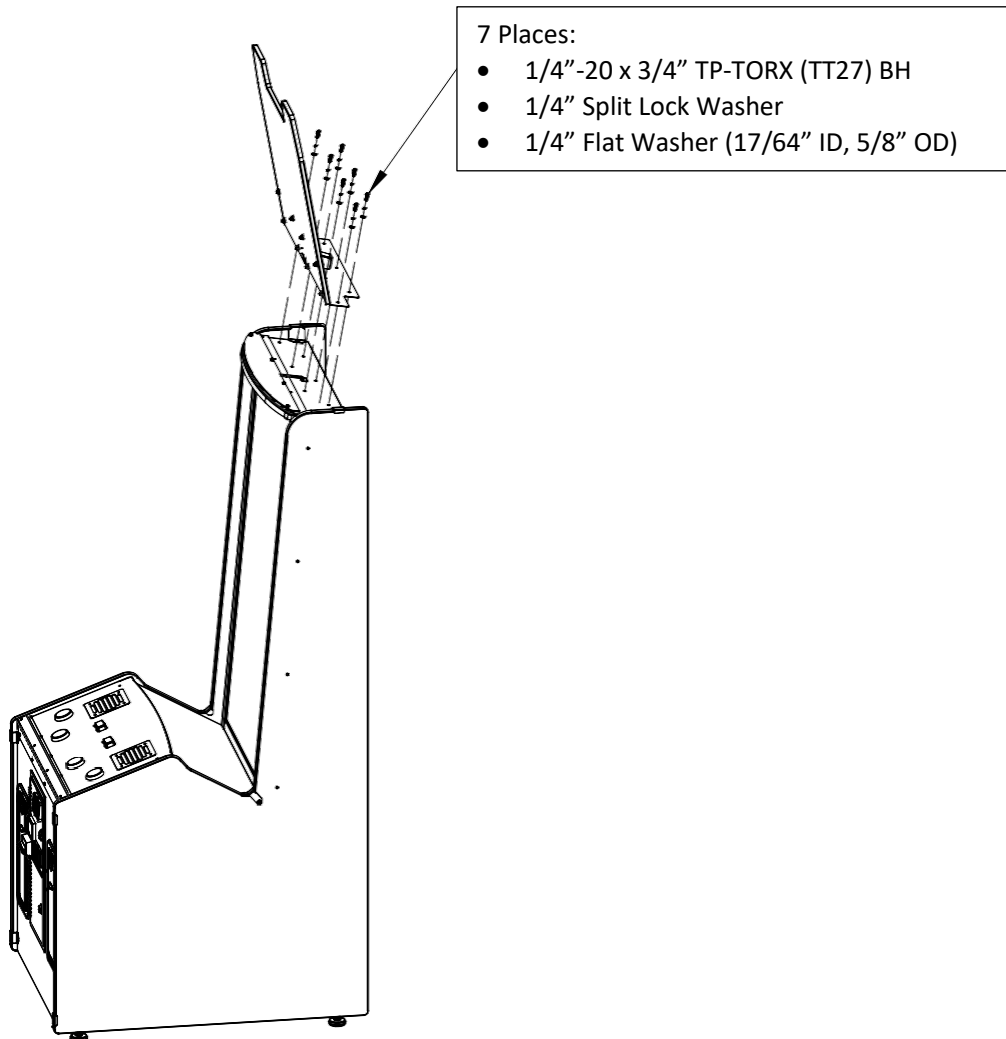

Startup Game

1. Plug in line cord to AC outlet.
2. Turn the power switch to ON.
3. Verify game display, sound, lights and controls are operating normally.

If not, turn off AC power and disconnect line cord. Refer to the diagnostic section of this manual.

Diagnostics and Adjustments

The Service Button Panel has four buttons, three of which can navigate the menu system.

The start and chop buttons can also advance through test menu screens.

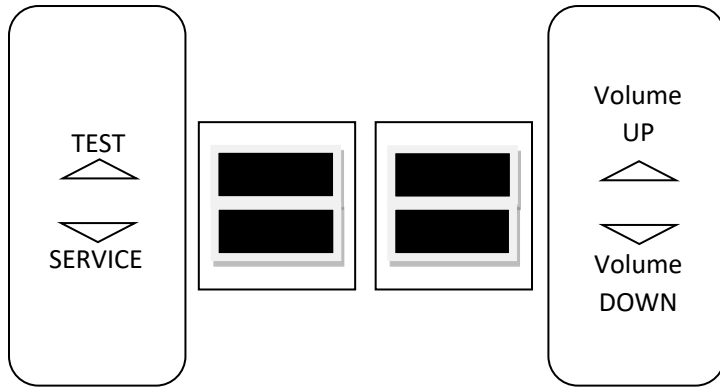

Navigating the Test Menu	
Button	Action
TEST/BACK (Not in Test Menu)	Enters Test Menu
TEST/BACK (In Test Menu)	Selects Highlighted Option
SERVICE (On Main Menu)	Exits Test Menu
SERVICE (Not on Main Menu)	Cancels Selection
VOLUME UP	Move Up
VOLUME DOWN	Move Down
START BUTTONS	Selects Highlighted Option

Basic Functional Test on Initial Power Up

See the Diagnostic Section for further information.

1. Enter the Switch Test menu and verify all switches function.
2. Enter the Sound Test menu and verify the audio works and is not distorted.
3. Enter the Coin Meter Test menu and verify the operation of the coin meter.
4. Enter the Cabinet Lamps Test menu and verify that all cabinet lights work correctly.
5. Enter the Watchdog Test menu, which reboots the game.
6. Upon a successful reboot, you are ready to adjust pricing, volume and other functions found in the Adjustments, Audits, and Diagnostics section.

Choppy Wood™

Test Menus

Main Menu

Choose from all available operator settings and menus here. You can use the test menu bracket and volume buttons to navigate. The chop buttons and start buttons are also available to use for easier navigation through the menus.

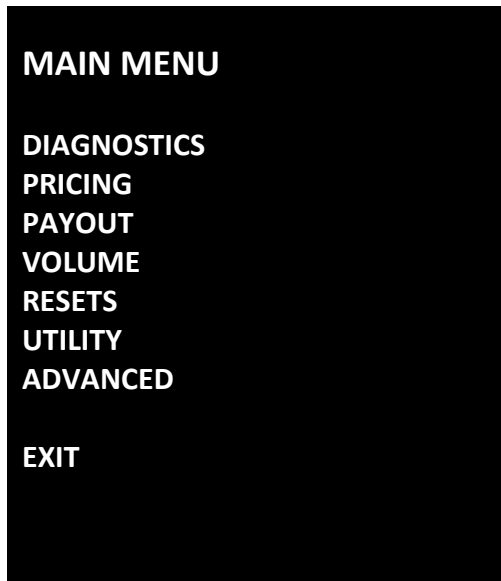

Diagnostics

This menu allows all game functions to be verified or diagnosed. You can improve collections by periodically verifying proper game function and operation.

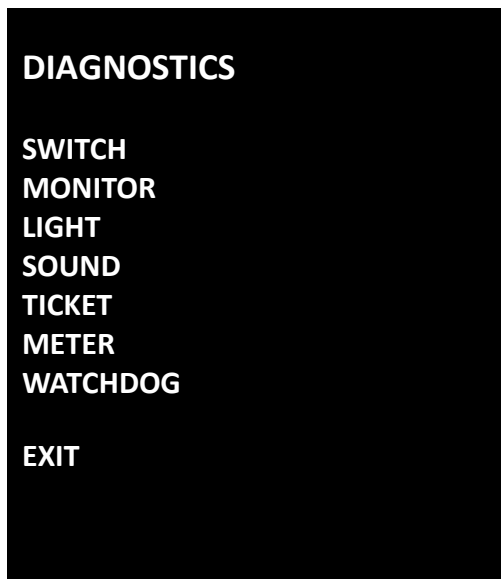

Choppy Wood™

(Diagnostics Menu Continued from Previous Page)

- **Switch** - Tests all the switches in the game in this diagnostic screen (Buttons, coin, test bracket, etc.)
- **Monitor**- Tests the monitor color and screen functionality
- **Light**- Tests all LED cabinet lighting
- **Sound**- Tests the audio on the speakers and woofer (100hz and 1000hz test.)
- **Ticket** - Tests the functionality of the ticket mech
- **Meter**- Tests the “hard” coin meter inside the cabinet
- **Watchdog**- Tests the functionality of the watchdog reset (If watchdog is functioning properly, game will reboot)

Pricing

This allows customization of coin values, currency denominations, and swipe value.

Pricing – Coins Active Menu (Default)

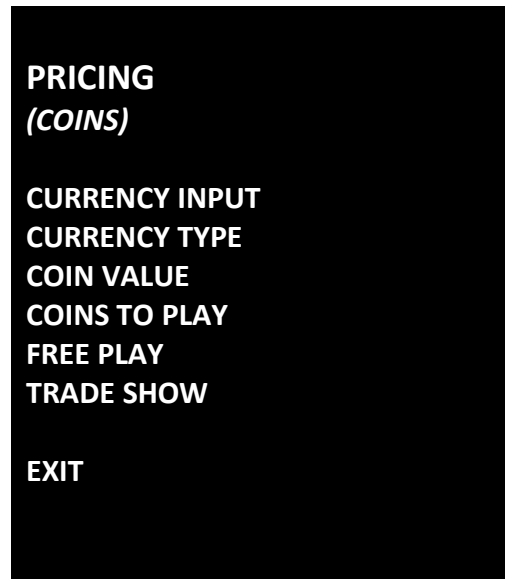

- **Currency Input:** Choose between: Tokens, Swipes, or Currency.
- **Currency Type:** Choose between: USD, Euro, GBP, YUAN (RMB).
- **Coin Value:** Money value of a coin. This is a very important setting and impacts payout. Default value: \$0.25.
- **Coins to Play:** Number of coins per credit.
- **Free Play:** No coins or swipes needed to play.
- **Trade Show-** Turn this mode on when operating on a trade show, sales floor, or demo floor. The game runs on free play and simulates ticket payouts without a ticket error appearing on the screen.

Choppy Wood™

(Pricing Menu Continued from Previous Page)

Pricing – Swipes Active Menu

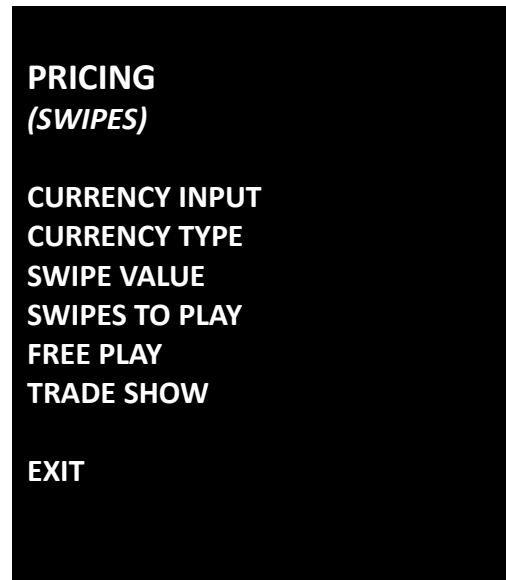

- **Currency Input:** Choose between: Tokens, Swipes, or Currency.
- **Currency Type:** Choose between: USD, Euro, GBP, YUAN (RMB).
- **Swipe Value:** Money value of a swipe. Default value: "\$1.00". This is a very important setting and impacts payout.
- **Swipes to Play:** Number of swipes per credit This setting is locked at 1 Swipe per credit.
- **Free Play:** No coins or swipes needed to play.
- **Trade Show-** Turn this mode on when operating on a trade show, sales floor, or demo floor. The game runs on free play and simulates ticket payouts without a ticket error appearing on the screen.

Payout

This menu allows for customization of target compensation, payout percentage, ticket value, E-ticket support (Paperless Tickets), and Jackpot compensation.

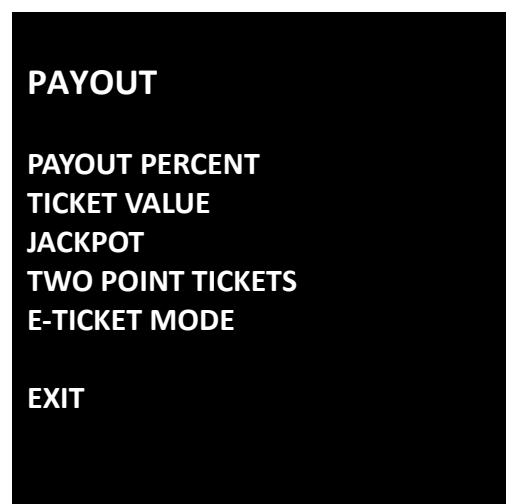

Choppy Wood™

(Payout Settings Continued from Previous Page)

- **Payout Percent**- Set your targeted payout percentage. 40% is the recommended payout setting when your pricing is at least \$1.00. IMPORTANT NOTE- *Choppy Wood* has a dynamic targeted payout system in place but it is a skill based redemption game. There will be some slight volatility and variation in payout among different skill level players.
- **Ticket Value**- Set the value of your tickets. Default value is "\$0.01" and is the recommended setting.
- **Jackpot**- The "Axe-Pot" (Jackpot) number on the tree changes and the customer wins the amount shown at the moment the Axe-Pot is reached. Operators can adjust the max jackpot in the test menu settings by accessing the "Payout Settings" menu. You will have a choice between various 3 number combos listed for the Axe-Pot to rotate:
 - 1000, 250, 100 (group 1)
 - 500, 250, 100 (group 2)
 - 100, 20, 10 (group 3)

Choose the jackpot number grouping that best suits your location. Recommended settings are, Group 2 for \$1.00+ per play locations and Group 3 for \$0.25 per play locations.

(Note - It is not recommended to raise the max jackpot to extremely high levels like 1000 or 500 if you plan on operating the game at a very low target payout percent. Doing so will limit the number of jackpots awarded and decrease the fun factor for the customer.)

- **Two Point Tickets**- When set to ON, this setting allows a single ticket dispensed to be worth 2 points in the game. This setting defaults to OFF.
- **E-Ticket Mode**- Raw Thrills supports the use of paperless tickets or "E-TICKETS" with our new "E-Ticket Mode". If you are using digital tickets via a card based system like Embed, Intercard, Semnox or equivalent system, you will need to activate E-Ticket Mode. This mode provides E-Ticket support to a 2-player simultaneous play experience like *Choppy Wood*. It splits the credits and E-ticket payout to the Player 1 and Player 2 sides of the game to two separate card swipers. Each player's payout and credits will be properly divided to the corresponding player's card.

Choppy Wood™

Resets Menu

All operator resets are available in this menu. Credits, tickets, audits, adjustments, are all accessible here. You can also factory reset the game from this menu which will restore all settings in the game to their original factory settings.

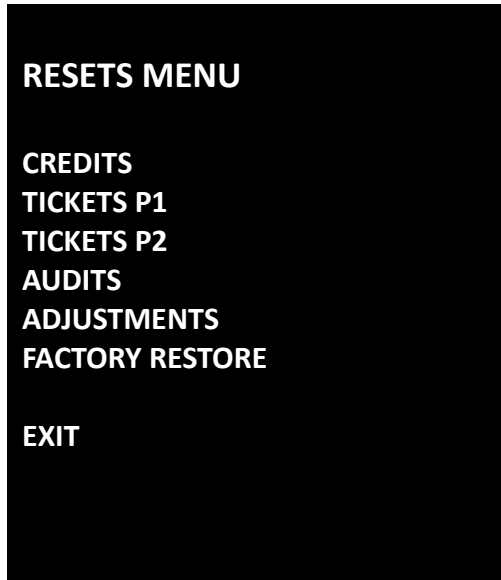

- **Credits**- Reset all credits to zero
- **Tickets P1**- Reset tickets won on the player 1 side
- **Tickets P2**- Reset tickets won on the player 2 side
- **Audits**- Reset all game audits to zero
- **Adjustments**- Reset all operator adjustments
- **Factory Restore**- Restores all settings and adjustments in the game to their original factory settings.

Utility Menu

Utilities is a miscellaneous menu of operator tools and settings. This includes periodic CRC checks to verify that software has not been corrupted or reporting an error.

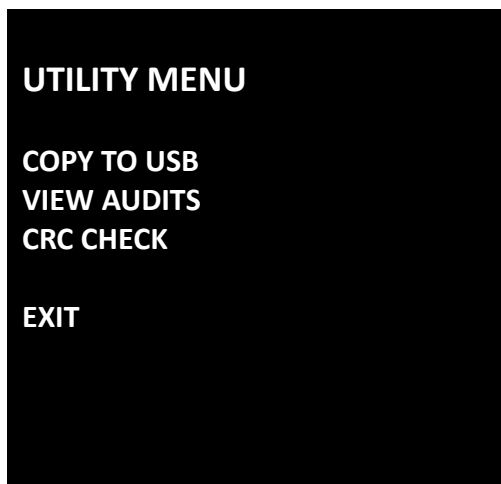

Choppy Wood™

(Utilities Menu Continued from Previous Page)

- **Copy to USB**- Allows you to upload your audits to an easy to read text file (.TXT) on a USB flash drive
- **View Audits**- Audit screens help assess game performance, find intermittent problems, decide whether to adjust game difficulty and game award, and help maximize earnings.
- **CRC Check**- Checks for errors in the game's files

Volume

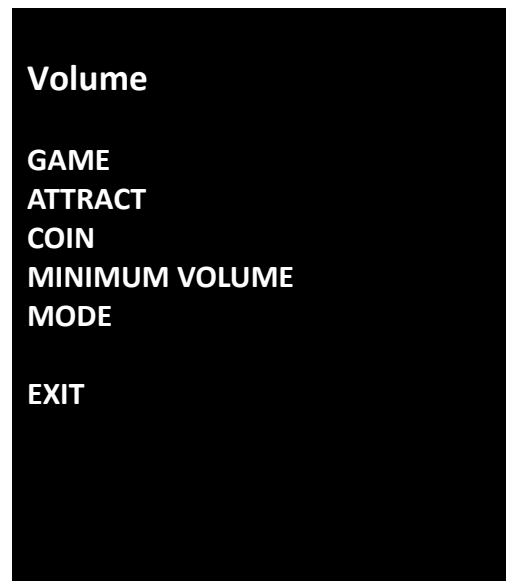

- **Game**- Adjusts the volume level during gameplay
- **Attract** - Adjusts the volume during the attract mode sequences
- **Coin**- Adjusts the volume level of the credit chime only (Independent setting of game and attract volume)
- **Minimum Volume**- Adjusts the minimum floor the volume can be lowered
- **Mode**- This allows you to set how frequently you want the volume to play during the attract mode. Choose from "None", "Occasionally", and "Always".

Choppy Wood™

Advanced

The advanced menu for *Choppy Wood* allows you to customize some gameplay features.

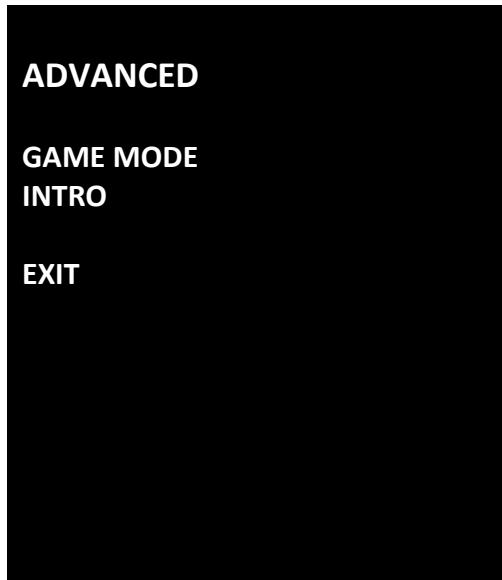

- **Game Mode**- Select between “Beginner” mode and “Normal” mode. Choose the mode that is best suited for your location.
 - Beginner- Slightly easier gameplay difficulty, shorter gameplay time, tailored for a younger clientele, and low per game price point.
 - Normal- Longer play time, tailored for a more diverse audience, and a higher per game price point.
- **Intro**- Turns on/off the quick tutorial intro at the beginning of each game. Default value is “On” and is the recommended setting.

Choppy Wood™

Keys to Maximizing Earnings and Collections

Card Swipe Locations

- Make Sure Your Game is Set to **Swipes Mode**:
 1. Hold the Test Button for 2 seconds to enter the Test Menu.
 2. Select “Pricing” from the menu.
 3. Select “Currency Input” from the menu.
 4. Select “Swipes” from the menu.
 5. Set “Swipe Value” to the currency equivalent of your swipe, or the payout will be incorrect.
THIS SETTING IS EXTREMELY IMPORTANT! (Example: If the card swipe is worth \$1.50 in your card system, set the swipe value to \$1.50 as well)

E-Ticket Locations

- Make Sure Your Game is Set to **E-Ticket Mode**:
 1. Hold the Test Button for 2 seconds to enter the Test Menu.
 2. Select “Payout” from the menu.
 3. Select “E-Ticket” and set to “On”

IMPORTANT NOTE: You must have two card swipers for E-Ticket mode to work. One for Player 1 side and one for Player 2 side.

Coin Locations

- Make Sure Your **Pricing & Coin Value** are Correct:
 1. Hold the Test Button for 2 seconds to enter the Test Menu.
 2. Select “Pricing” from the menu.
 3. Select “Coins to Play” and set the desired amount of coins per game *Choppy Wood™*.
 4. After setting the coins per play, set “Coin Value” to the currency equivalent of your coin, or the payout will be incorrect.
THIS SETTING IS EXTREMELY IMPORTANT! (Example: If your coin is worth \$0.25, set “Coin Value” to \$0.25 as well)

2 Point Ticket Locations

- Make Sure the **2 Point Ticket** Setting is Activated:
 1. Hold the Test Button for 2 seconds to enter the Test Menu.
 2. Select “Payout” from the menu.
 3. Select “Two Point Ticket” and set to “On”. (Your tickets are now worth 2Pts each)

IMPORTANT NOTE: Only use this setting if your tickets are worth 2 points per ticket or the payout will be incorrect.

Choppy Wood™

More Tickets = More Fun = Better Earnings

- We recommend using the default payout setting of 40% to maximize earning potential and fun factor for the players. To set the “Payout Percentage”:
 1. Hold the Test Button for 2 seconds to enter the Test Menu.
 2. Select “Payout” from the menu.
 3. Select “Payout Percent” and adjust to desired amount.

IMPORTANT NOTE: Choppy Wood™ will dynamically adjust to your desired payout setting.

Choose Mode of Play Best Suited for Your Location

- There are two games to choose from:
 - Beginner – Best suited for a younger audience.
 - Normal – Best suited for a more diverse audience.
- To set the “Game Mode”:
 1. Hold the Test Button for 2 seconds to enter the Test Menu.
 2. Select “Advanced” from the menu.
 3. Choose between “Normal” and “Beginner”.

Choppy Wood™

PC Hardware

Your *Choppy Wood™* game may ship with either a **DELL INSPIRON 3050** computer or a **Fujitsu IMP-3313-S4-4G-HD Mini PC computer** ("Fujitsu Mini PC"). The Dell Inspiron 3050 computer is square in shape has a "Dell" logo on it while the Fujitsu computer is rectangular in shape and has no logo. Listed below are the BIOS settings for each computer.

NOTICE

Both the **DELL INSPIRON 3050** and **FUJITSU MINI PC** ship with correct BIOS settings. Making changes to the BIOS different from the description below may adversely affect game functions.



(Above- Dell Inspiron 3050)



(Above- Fujitsu Mini PC)

Fujitsu Mini BIOS

To Access BIOS Settings:

With the computer powered off, plug a USB keyboard into an open USB slot, hold 'F2' key and turn the computer on. Continue holding the F2 key until the BIOS Setup screen appears.

Note: All settings that are not listed should remain their default values

Advanced

- + Graphics Configuration
 - Internal Graphics [Enabled]
 - Primary Display [IGD]
 - IGD Memory [512M]

Power

- Power Failure Recover [Always ON]

Boot

- Prefer USB Boot [Enabled]

Note: After exiting BIOS settings screen, power-cycle the cabinet by using the cabinet's main power switch.

Choppy Wood™

Dell Inspiron 3050 BIOS

To Access BIOS Settings:

With the computer powered off, plug a USB keyboard into an open USB slot, hold 'F12' key and turn the computer on. Continue holding the F12 key until a menu with a blue background appears. From the menu, select 'BIOS Setup'

Main

- Nothing

Advanced

- Intel® SpeedStep™ [Enabled]
- Virtualization [Enabled]
- Integrated NIC [Enabled]
- SATA Operation [AHCI]
- Adapter Warnings [Enabled]

- + Miscellaneous Device
 - Nothing

- + Power Options
 - Wake Up by Integrated LAN [Disabled]
 - AC Recovery [Enabled]
 - Auto Power On [Disabled]

Security

- Nothing

Boot

- Boot List Option [Legacy]
- File Browser Add Boot Option
- File Browser Del Boot Option
- Secure Boot [Disabled]
- Load Legacy Option Rom [Enabled]
- 1st Boot Priority [USB Storage Device]

Exit

- Nothing

Note: After exiting BIOS settings screen, power-cycle the cabinet by using the cabinet's main power switch.

Choppy Wood™

PC Hard Drive Recovery

Symptoms requiring PC hard drive recovery include

- File Test reports bad or missing files.
- Game fails to finish loading during startup.
- After resetting the AC power, an error is reported.
- Erratic Game or Attract Mode.
- The following screen:



The only way to repair corrupt files is to reinstall the software as described below:

Computer

The computer contains sensitive components. Do not handle roughly. Call your distributor before servicing its internal components. Ask about warranty information as it relates to the PC.

Do **not** use the PC on/off switch. Turn AC power on or off with the cabinet power switch.

Steps to Re-install the software:

(NO DVD Restoration. USB Thumb Drive is used on the *Dell Inspiron 3050 PC* or *Fujitsu Mini*)

1. With game and PC on, verify that the RIO board has power. If not, see Troubleshooting.
2. Open the coin door
3. Insert the recovery USB thumb drive (included in your game) into the USB port on the Test button bracket inside the coin door.
4. Turn cabinet power switch to OFF. Wait 30 seconds.
5. Turn cabinet power switch to ON.
6. Select the *Choppy Wood™* restore version from the menu and follow on screen instructions.
7. If recovery does not begin, check to ensure USB Drive is inserted correctly and is not damaged.
8. Initial software loading may take several minutes. Check progress periodically.
Do not interrupt power or reset the game during recovery.
9. When software has been loaded, a message indicates that restore is complete. When instructed to remove USB Drive, wait 15 seconds to remove the drive from the PC.
10. Turn cabinet power switch off and then turn the cabinet on again. Your game will now be restored.

Choppy Wood™

Troubleshooting

Warning: Review safety chapter before making any adjustments to game.

Problem	Possible Cause	Solution
Game will not power up.	Game not plugged in.	Plug game into AC outlet.
	Game not turned on.	Turn on main power switch.
	Game fuse is blown.	Check and replace fuse. See Specification section for fuse values.
	No power to receptacle.	Test AC outlet and plug game into powered outlet.
	PC BIOS set incorrectly.	See BIOS Settings section.
	Flash Drive Installer is left connected to PC.	Disconnect Flash Drive Installer and power cycle the game.
Buttons do not work.	Faulty micro switch.	Replace the micro switch on the button and re-test. Verify that the wires are connected to the correct spades on the micro switch.
	Faulty wiring.	Disconnect the cabinet from AC power. Verify that all wires are firmly connected to each button and the RIO. Verify that no wires are frayed or improperly shorting to ground. Verify that wires are connected to the correct spades on the micro switches.
	Faulty RIO.	Ensure all connections to RIO are secure. Replace RIO if faulty.
Neither buttons nor audio work.	RIO connected to faulty USB port (boot message may indicate not detected)	To test a USB port, turn off the game, disconnect the device from the port, and then connect the game dongle to the port. Reboot the game. A No Dongle message indicates the port is bad. If the game starts, the port is working. After the test, reconnect all devices to the correct USB ports and reboot.

Choppy Wood™

Problem	Possible Cause	Solution
No sound or bad sound.	Bad connection.	Check connection to speakers.
	Volume set too low.	Use VOL UP button on Test panel to raise volume
	Faulty wiring.	Verify all wires are firmly connected to the speakers, RIO, and green computer audio port. Verify that each wire is connected to the correct port and no wires are frayed or improperly shorting to ground.
	Blown speakers.	Remove the grill and inspect each speaker for visible damage. Run the Sound Test from System Tests in the Operator Menu to verify each speaker is working.
	Reversed wires.	A weak or low muffled sound is a sign of reversed speaker wires. Check for reversed wires on each speaker.
Faulty RIO.	To verify audio is working at the computer, connect stereo headphones to the green computer audio port.	

Constant low audio hum.	Faulty power supply.	Check external DC supply and the PC supply.
	Open ground.	Check all ground wires in cabinet. Ensure AC wall outlet is properly grounded

Game does not load.	PC hard drive failure.	Recover hard drive. See Flash Installer Document or visit www.rawthrills.com for latest software version download.
PC Drive test reports “bad” or “missing” files.		
Game fails to finish loading.		
After resetting, game still reports an error.		
Erratic game mode or attract mode.		
WARNING! Data files Corrupted. (Game Operation May Become Unstable.) Use “Test” Switch to Enter Test Mode and Run “File Test.”		

Choppy Wood™

Problem	Possible Cause	Solution
Game Resets	Bad file.	Run USB Flash Installer to reinstall game software.
Coin meter does not click during test.	No pulse to meter.	Check wiring from meter to RIO board.
	Faulty meter.	Replace coin meter.
	Blown fuse(s) on RIO	Replace 12vdc 5A fuse(s) on RIO.
Improper number of credits given when coins or bills are inserted.	Incorrect setting in Pricing Adjustments.	Adjust pricing settings.
	Faulty wiring.	Disconnect cabinet from AC power. Verify wires are firmly connected to coin mech and bill validator and ground wires are properly connected. Verify no wires are frayed or shorting to ground.
	Faulty coin mech.	Verify coin mech is not jammed. Ensure coin mech is properly aligned and latched to coin door.
Exits Test Mode every 3 seconds.	Test button stuck in ON position.	Slide or toggle button off after Test Menu appears
NO VIDEO message	Video cables not plugged in properly.	Reattach and tighten power and video cable to display adaptor.
No Signal	Video cable not secure.	Reattach and tighten power and video cable to display adaptor.
	PC not turned on.	Turn PC power switch on. Ensure IEC cable tightly plugged in. Trace cable back to source to ensure continuity.
Dongle Not Present	Dongle missing or disconnected.	Find dongle cable and reseal in USB port.
	Faulty USB port.	Insert dongle cable in different USB port.
Connect RIO Board or RIO Board Missing.	USB cable disconnected.	Check USB connection from PC to RIO board.
	No Power to RIO board.	Check for proper voltage (+5V, +12V) at RIO P1 connector.

Choppy Wood™

Choppy Wood™

Electrical and Mechanical Illustrations

**NOTE: PLEASE CHECK FOR THE LATEST VERSION OF GAME SOFTWARE AND MANUAL AT
WWW. RAWTHRILLS.COM**



Choppy Wood Assembly - 55" LCD (BOM on next page)

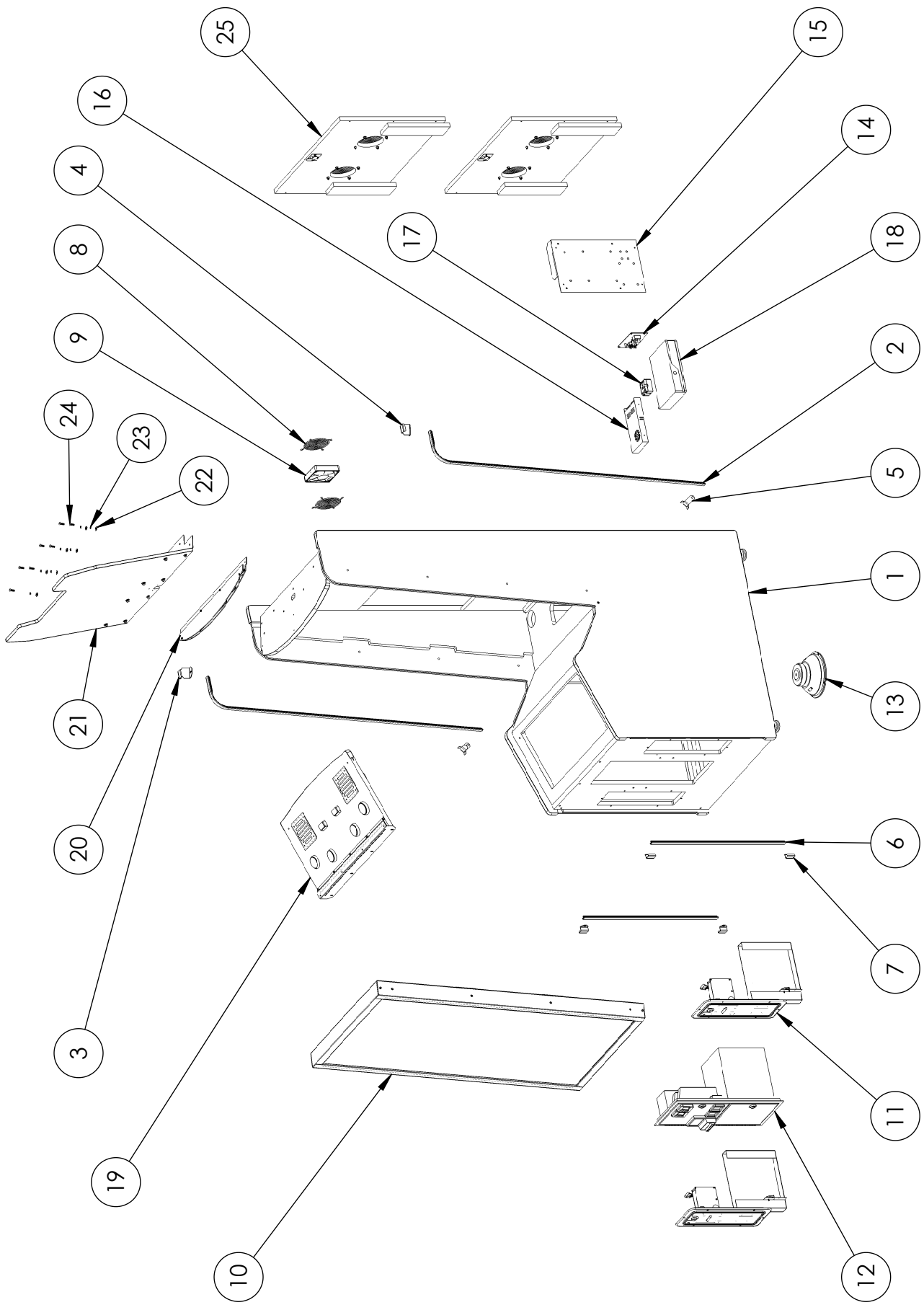

- NOT SHOWN:
> Selective Hardware
> 500-00131-01 - RGB LED Strip Reel
- 2X 140CM / 84 LEDs (installed in #2)
- 2X 65CM / 39 LEDs (installed in #6)



Choppy Wood Assembly - 55" LCD: BOM

ITEM NO.	PART NUMBER	DESCRIPTION	QTY.
1	601-00769-01	Choppy Wood Cabinet	1
2	603-00718-01 (55.5 in)	LED T-Molding Extrusion - 55.5"	2
3	600-01717-01	Left Side Panel T-Molding Clip	1
4	600-01718-01	Right Side Panel T-Molding Clip	1
5	600-01939-01	Flanged LED T-Molding Clip	2
6	603-00718-01 (25.75 in)	LED T-Molding Extrusion - 25.75"	2
7	600-01942-01	LED T-Molding Clip	4
8	800-00001-00	120mm Wire Fan Guard	2
9	820-00012-00	Cooling Fan(standard size): 12VDC, 3W, 80CFM	1
10	55-LCD_Assy	55" LCD Assembly	1
11	800-00043-01	Ticket Dispenser Door Assembly (Suzo-Happ)	2
12	800-00005-01	Mid-Width Coin Door Assembly (Suzo-Happ)	1
13	2-1-18-00-00-000	8" Woofer, 4 Ohm, Poly-Mica Cone (Goldwood)	1
14	AC_Plate_Assy	AC Power Plate Assembly	1
15	RIO_Hardware_Assy	RIO Assembly (with Mounting Plate)	1
16	500-00193-01	Switching Power Supply: 320.4W, 12V, 26.7A, PFC (Mean Well RSP-320-12)	1
17	800-00040-01	Solid State Relay (Magnecraft 6210DSX-1)	1
18	850-00024-01	Fujitsu PC (IMP-3313-S4-4G-HD)	1
19	Choppy_Control_Panel_Assy	Control Panel Sub-Assembly	1
20	Choppy_Marquee_Light_Assy	Marquee Light Sub-Assembly	1
21	Choppy_Marquee_Assy	Marquee Sub-Assembly	1
22	McMaster-Carr - 97416A119	Black-Oxide Steel SAE Flat Washer, 1/4" Screw Size, 0.281" ID, 0.625" OD	7
23	McMaster-Carr - 93711A500	Black Oxide 18-8 Stainless Steel Split Lock Washer for Socket Head Cap Screw, 1/4" Screw Size, 0.260" ID	7
24	McMaster-Carr - 96075A219	Alloy Steel Tamper-Resistant Torx Rounded Head Screws, 1/4"-20 Thread Size, 3/4" Long	7
25	Choppy_Back_Door_Assy	Back Door Sub-Assembly	2

ITEM NO.	PART NUMBER	DESCRIPTION	QTY.
26	600-01845-01	55" LCD Frame Long Bracket	2
27	Monitor_Foam_Tape (47.25)	Single Side Adhesive: .25" T x .50" W x 47.25" L	2
28	809-00012-01	55" Open Frame LCD (with Glass)	1
29	600-01846-01	55" LCD Frame Short Bracket	2
30	Monitor_Foam_Tape (26.5)	Single Side Adhesive: .25" T x .50" W x 26.50" L	2
31	McMaster-Carr - 90272A192	Steel Phillips Rounded Head Screws, 8-32 Thread Size, 3/8" Long	12
32	McMaster-Carr - 91249A192	Phillips Rounded Head Screw, Black- Oxide 18-8 Stainless Steel, 8-32 Thread Size, 3/8" Long	4

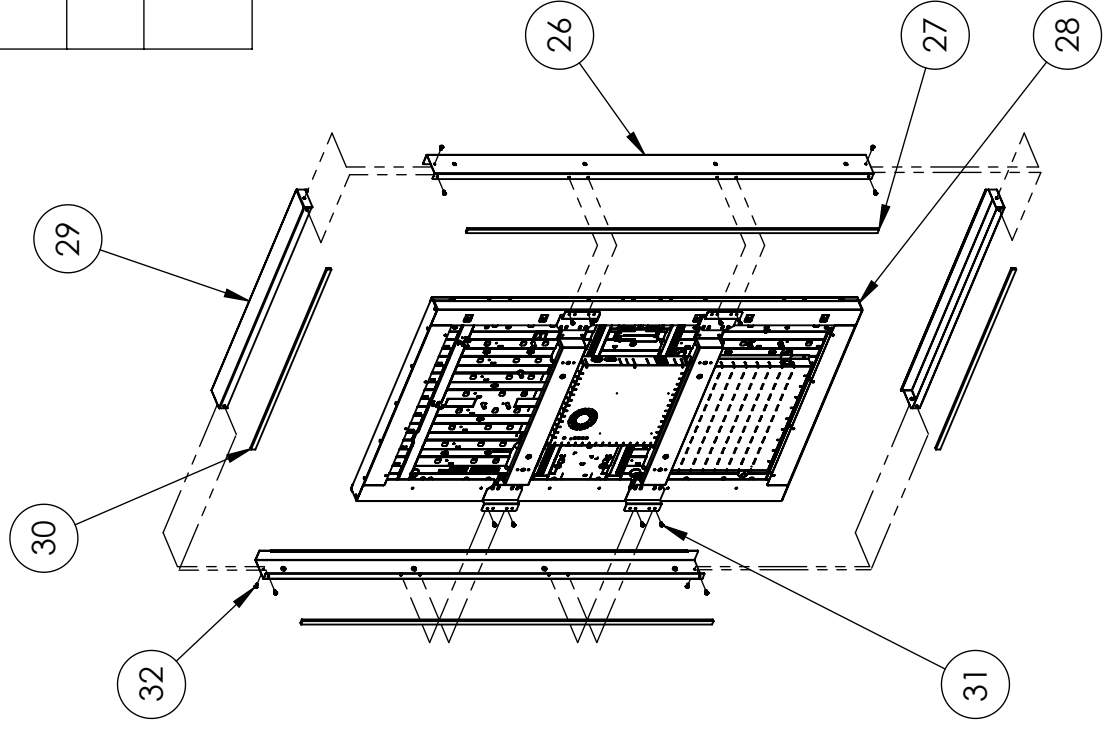

Choppy Wood 55" LCD Assembly



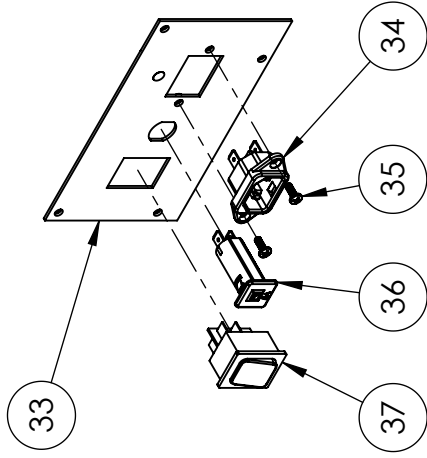

ITEM NO.	PART NUMBER	DESCRIPTION	QTY.
33	600-01681-01	AC Electronics Plate	1
34	703W-00/08	AC Receptacle: 250V, 15A (Qualitek)	1
35	McMaster-Carr - 90272A146	Steel Phillips Rounded Head Screws, 6-32 Thread Size, 3/8" Long	2
36	T9-611P-6	Thermal Circuit Breaker: 240VAC, 6A, Snap-in, Fuseholder, 1-Pole (Schurter)	1
37	1832.3312	Rocker Switch (DPST): 250VAC, 20A (Marquardt)	1

Choppy Wood AC Power Plate Assembly



ITEM NO.	PART NUMBER	DESCRIPTION	QTY.
38	600-01501-01	RIO Mounting Plate (w/ Motion Control PCB)	1
39	500-00040-01	RIO PCB	1
40	500-00194-01	5V, 5A Switching Regulator PCB (12V input)	1
41	McMaster-Carr - 90316A192	18-8 Stainless Steel Hex Washer Head Slotted Machine Screw, 8-32 Thread, 3/8" Length	10

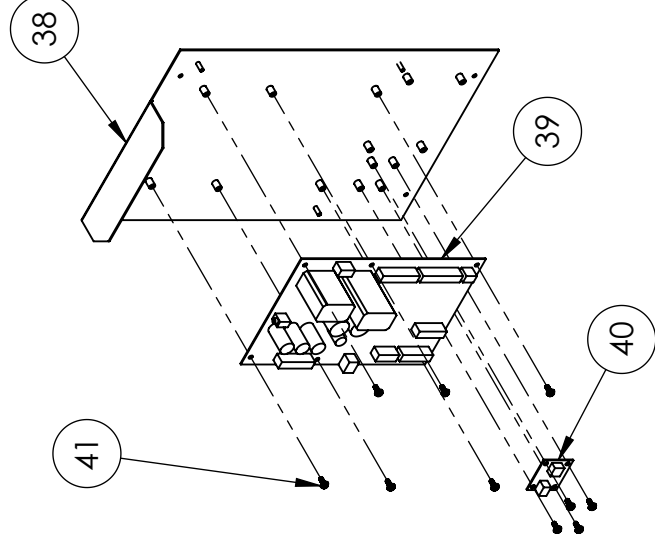

Choppy Wood RIO Assembly (with Mounting Plate)

ITEM NO.	PART NUMBER	DESCRIPTION	QTY.
42	601-00792-01	Control Panel	1
43	702-00015-01	Large Round IPB - RED	2
44	702-00019-01	Large Round IPB - BLUE	2
45	702-00074-01	Large Rectangular IPB - GREEN, "START" included with IPBs	2
46	Screw-in Ring Nut		6
47	600-01780-01	Speaker Mounting Bracket	2
48	2-1-10-00-00-000	5.25", 8 Ohm Full Range Speaker (Goldwood)	2
49	McMaster-Carr - 90126A011	Zinc-Plated Steel SAE Flat Washer, Number 10 Screw Size, 0.219" ID, 0.500" OD	8
50	McMaster-Carr - 90631A411	Low-Strength Steel Nylon-Insert Locknut, Zinc-Plated, 10-32 Thread Size, 3/8" Wide, 15/64" High	8
51	Choppy_Wood_Panel_Light_Assy	Control Panel Light Sub-Assembly	1
52	McMaster-Carr - 97416A113	Black-Oxide Steel SAE Flat Washer, Number 8 Screw Size, 0.188" ID, 0.438" OD	5
53	McMaster-Carr - 96075A143	Alloy Steel Tamper-Resistant Torx Rounded Head Screws, 8-32 Thread Size, 3/4" Long	5

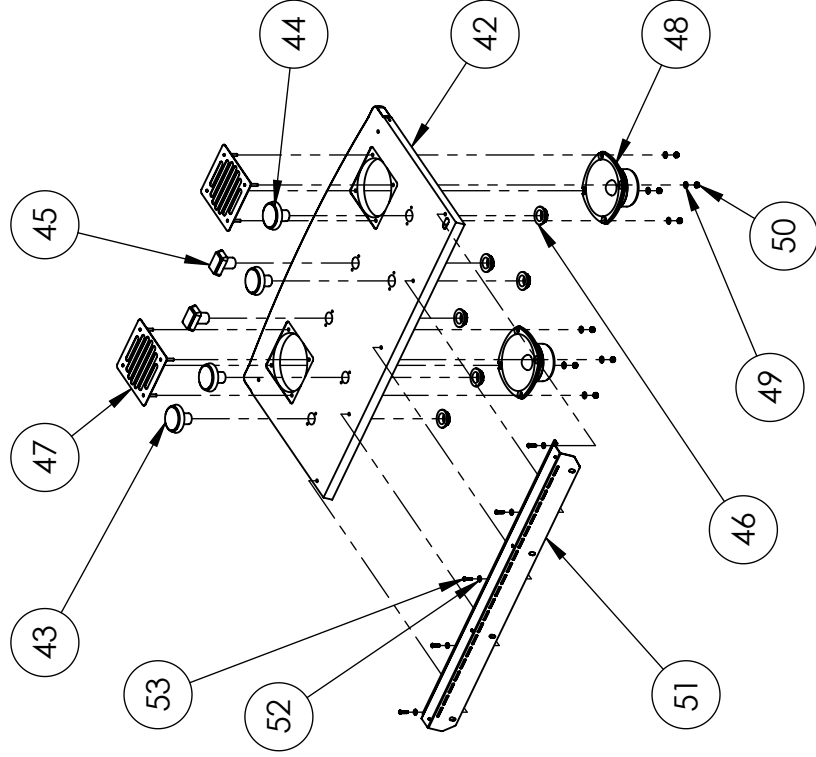

Choppy Wood Control Panel Sub-Assembly

ITEM NO.	PART NUMBER	DESCRIPTION	QTY.
54	600-01866-01	CP Edge Bracket	1
55	603-00799-01	Edge Diffuser Acrylic	1
56	McMaster-Carr - 90675A007	Steel Locknut with External-Tooth Lock Washer, Zinc-Plated, 6-32 Thread Size, 5/16" Wide	4
57	500-00216-01 (70 CM)	RGB Side Emitting LED Strip Reel - 90LED/M: 70CM / 63 LEDs	1

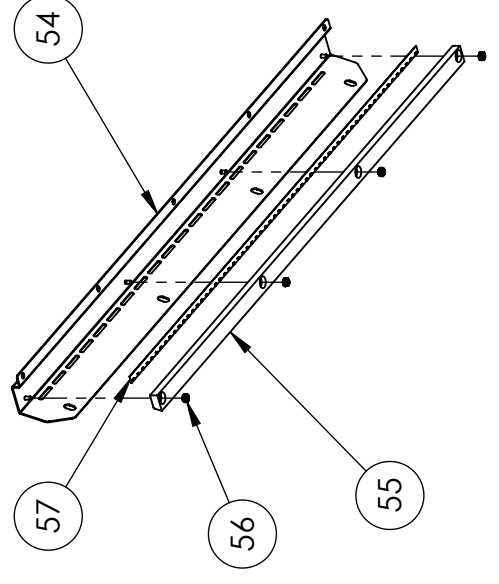

Choppy Wood Control Panel Light Sub-Assembly

ITEM NO.	PART NUMBER	DESCRIPTION	QTY.																
58	600-01943-01	Marquee Light Panel	1																
59	500-00162-01 (15 CM)	White LED Strip Reel w/ Foam Tape: 15CM / 9 LEDs	2																
60	500-00162-01 (25 CM)	White LED Strip Reel w/ Foam Tape: 25CM / 15 LEDs	2																
61	500-00162-01 (30 CM)	White LED Strip Reel w/ Foam Tape: 30CM / 18 LEDs	2																
62	500-00162-01 (35 CM)	White LED Strip Reel w/ Foam Tape: 35CM / 21 LEDs	2 </tr <tr> <td>63</td> <td>McMaster-Carr - 90272A151</td> <td>Steel Phillips Rounded Head Screws, 6-32 Thread Size, 3/4" Long</td> <td>4</td> </tr> <tr> <td>64</td> <td>McMaster-Carr - 94639A289</td> <td>Nylon Unthreaded Spacers, 1/4" OD, 5/16" Length, for Number 8 Screw Size</td> <td>4</td> </tr> <tr> <td>65</td> <td>600-01945-01</td> <td>Marquee Light Cover PETG</td> <td>1</td> </tr> <tr> <td>66</td> <td>McMaster-Carr - 90675A007</td> <td>Steel Locknut with External-Tooth Lock Washer, Zinc-Plated, 6-32 Thread Size, 5/16" Wide</td> <td>4</td> </tr>	63	McMaster-Carr - 90272A151	Steel Phillips Rounded Head Screws, 6-32 Thread Size, 3/4" Long	4	64	McMaster-Carr - 94639A289	Nylon Unthreaded Spacers, 1/4" OD, 5/16" Length, for Number 8 Screw Size	4	65	600-01945-01	Marquee Light Cover PETG	1	66	McMaster-Carr - 90675A007	Steel Locknut with External-Tooth Lock Washer, Zinc-Plated, 6-32 Thread Size, 5/16" Wide	4
63	McMaster-Carr - 90272A151	Steel Phillips Rounded Head Screws, 6-32 Thread Size, 3/4" Long	4																
64	McMaster-Carr - 94639A289	Nylon Unthreaded Spacers, 1/4" OD, 5/16" Length, for Number 8 Screw Size	4																
65	600-01945-01	Marquee Light Cover PETG	1																
66	McMaster-Carr - 90675A007	Steel Locknut with External-Tooth Lock Washer, Zinc-Plated, 6-32 Thread Size, 5/16" Wide	4																

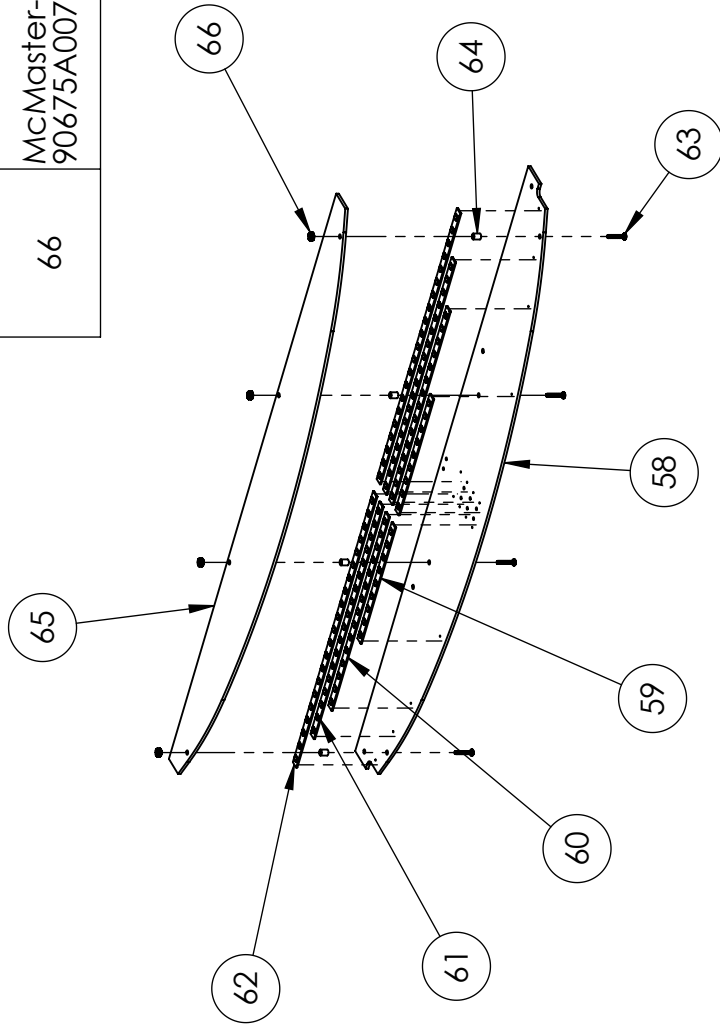

Choppy Wood Marquee Light Sub-Assembly



ITEM NO.	PART NUMBER	DESCRIPTION	QTY.
67	601-00772-01	Topper Backboard	1
68	600-01867-01	Topper Bracket	1
69	McMaster-Carr - 96075A219	Alloy Steel Tamper-Resistant Torx Rounded Head Screws, 1/4"-20 Thread Size, 3/4" Long	8
70	McMaster-Carr - 93711A500	Black Oxide 18-8 Stainless Steel Split Lock Washer for Socket Head Cap Screw, 1/4" Screw Size, 0.260" ID	8
71	McMaster-Carr - 97416A119	Black-Oxide Steel SAE Flat Washer, 1/4" Screw Size, 0.281" ID, 0.625" OD	8
72	600-01720-01	Marquee Harness Bracket	1
73	McMaster-Carr - 95638A194	Tamper-Resistant Screw for Sheet Metal, Pin-in-Torx, 18-8 Stainless Steel, Button Head, Number 8 Size, 1/2" Long, PAINT BLACK	3

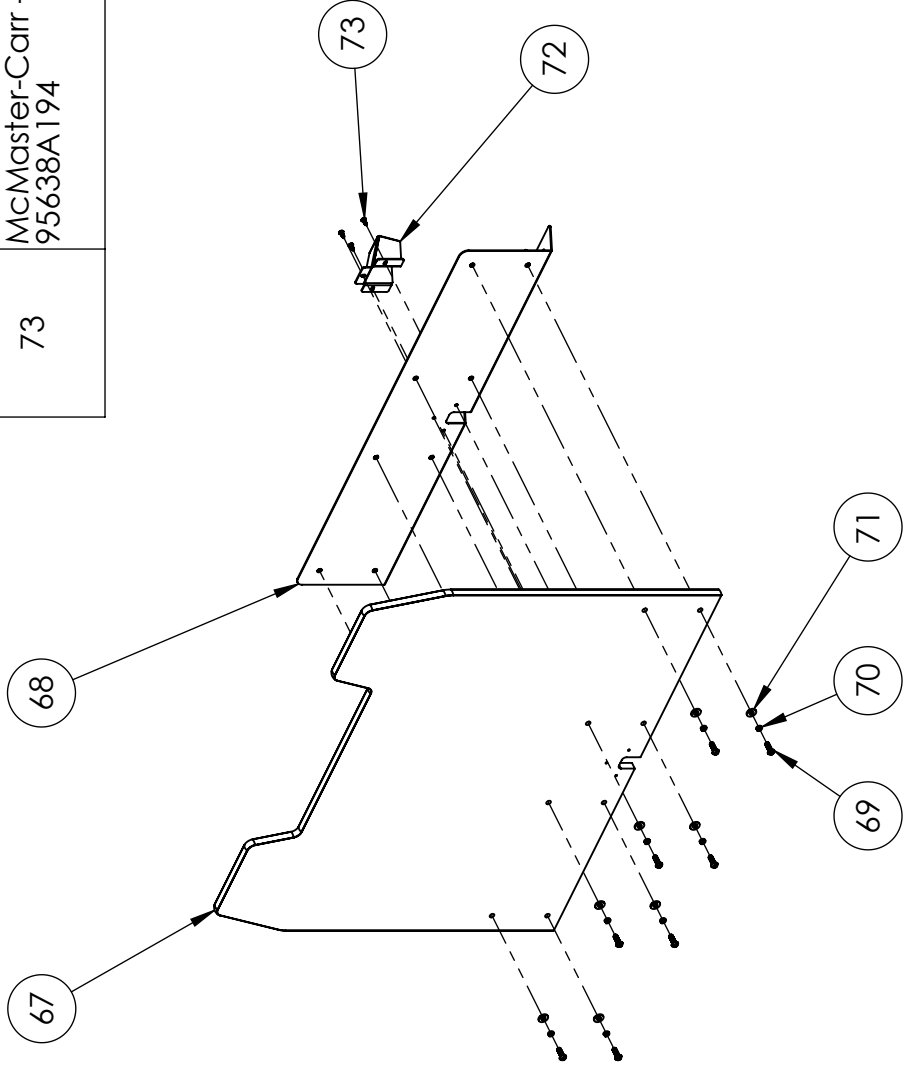

Choppo Wood Marquee Sub-Assembly

ITEM NO.	PART NUMBER	DESCRIPTION	QTY.
74	601-00770-01	Back Door	1
75	800-00001-00	120mm Wire Fan Guard	2
76	McMaster-Carr - 90272A201	Steel Phillips Rounded Head Screws, 8-32 Thread Size, 1-1/4" Long	8
77	McMaster-Carr - 90126A009	Zinc-Plated Steel SAE Washer for Number 8 Screw Size, 0.188" ID, 0.438" OD	8
78	McMaster-Carr - 90631A009	Low-Strength Steel Nylon-Insert Locknut, Zinc-Plated, 8-32 Thread Size	8
79	600-00043-01	Lock Retainer Plate	1
80	McMaster-Carr - 90054A196	Hex Washer Head Screw for Sheet Metal, Zinc-Plated Steel, Slotted, Number 8 Size, 5/8" Length	3
81	150-00001-00	Standard Door Lock Assembly (for 3/4" Panels)	1

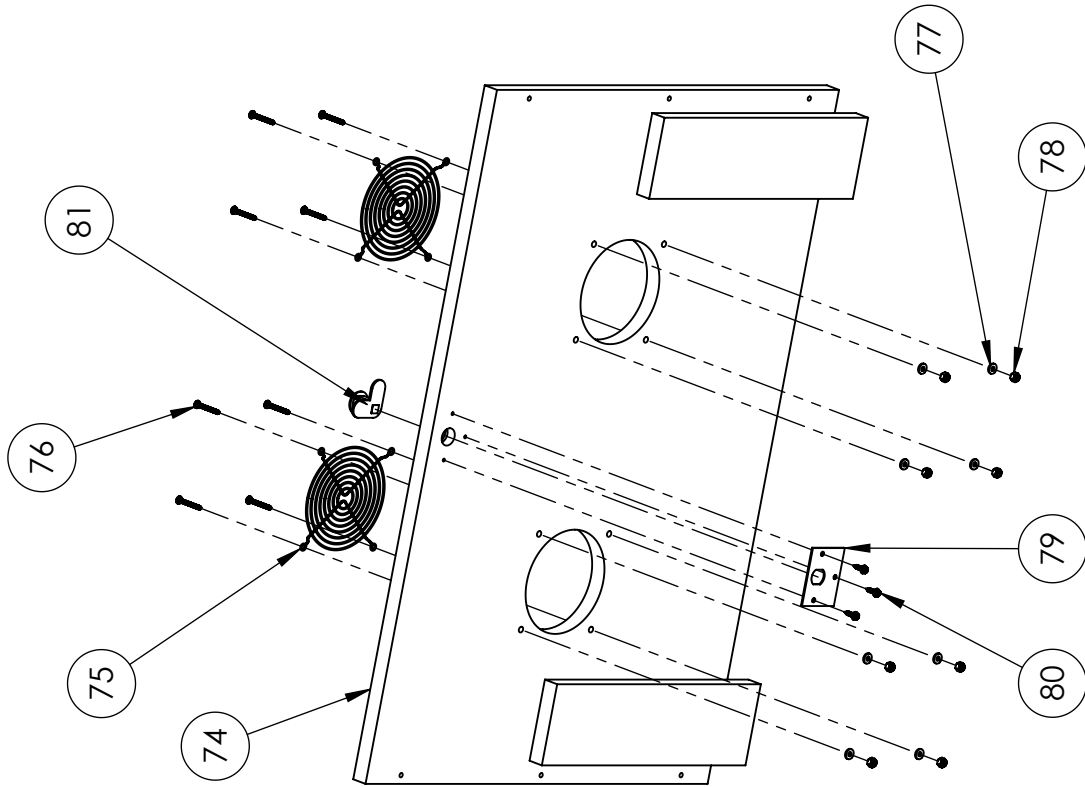

Choppy Wood Back Door Sub-Assembly

ITEM NO.	PART NUMBER	DESCRIPTION	QTY.
82	606-01209-01	Choppy Wood - Front Panel Decal	1
83	606-01212-01	Choppy Wood - CP Edge Front Decal	1
84	606-01213-01	Choppy Wood - CP Edge Top Decal	1
85	606-01201-01	Choppy Wood - Control Panel Decal	1
86	606-01210-01	Choppy Wood - Rear Control Panel Decal	1
87	606-01211-01	Choppy Wood - Topper Backboard Decal	1
88	606-01208-01	Choppy Wood - Left Side Panel Decal	1
89	606-01207-01	Choppy Wood - Right Side Panel Decal	1

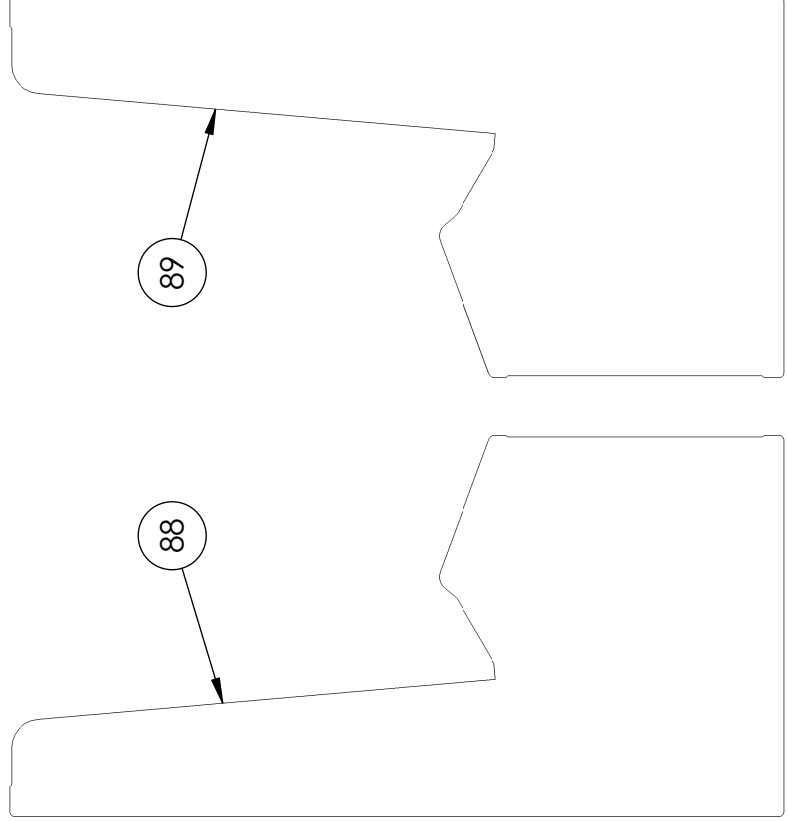
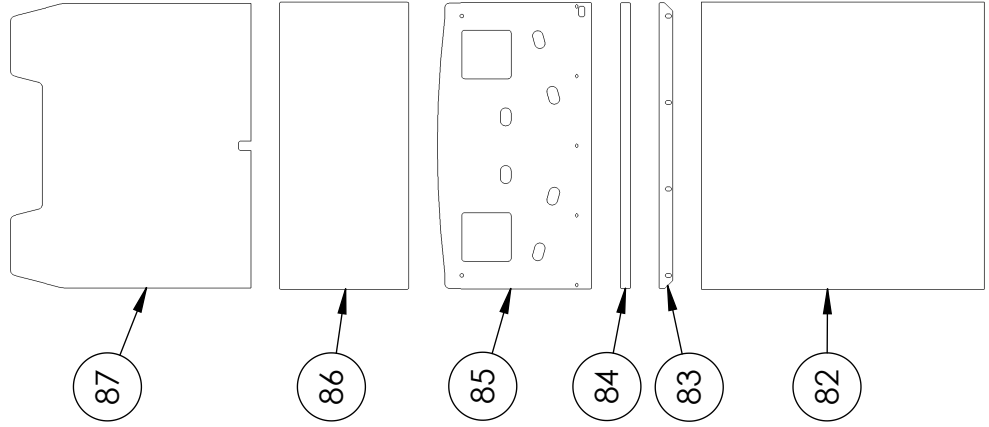

SCALE 1:20



Choppy Wood
Art Decals

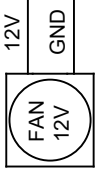

CABINET COOLING FAN (2X)

RELAY CONTROLLED AC POWER



AUDIO OUT

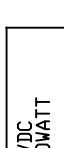
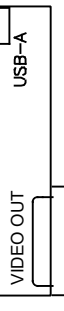
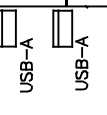

POWER SUPPLY

55" LCD DISPLAY

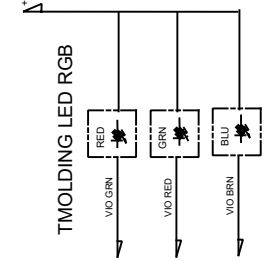

PC AC POWER

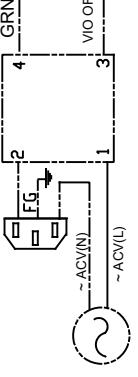

PC WATCHDOG RELAY
MAGNECRAFT
PN 6210AXXSZS-DC3

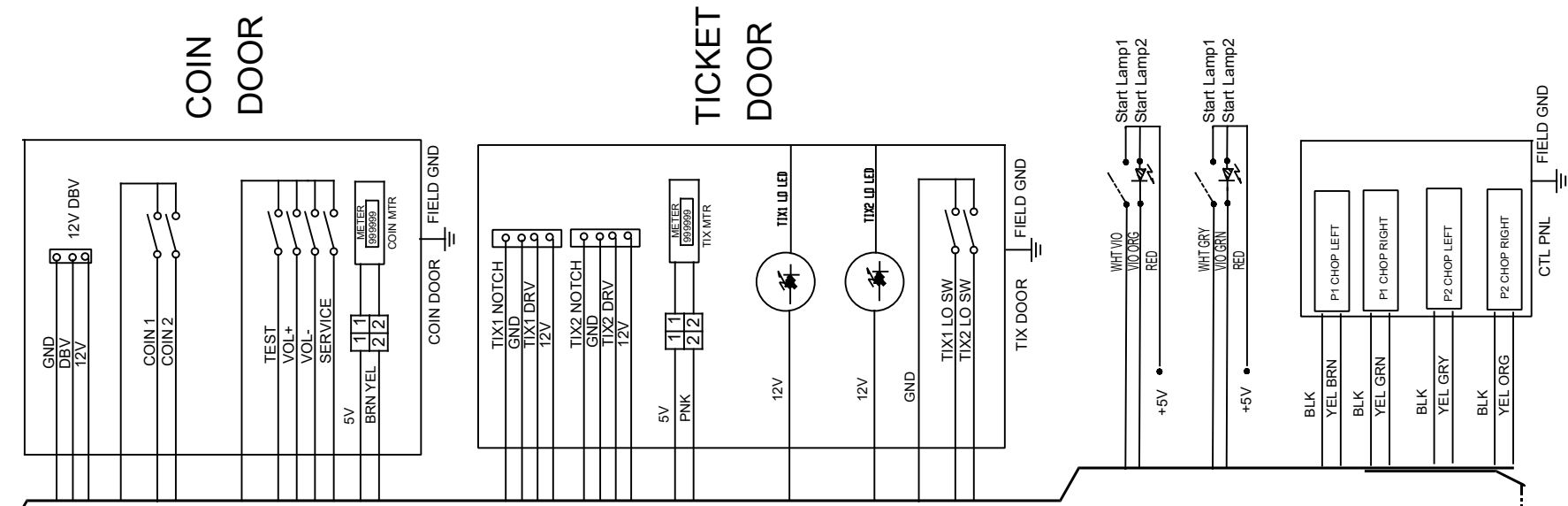

COIN DOOR

TICKET DOOR

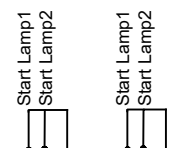

Start Lamp 1

Start Lamp 2

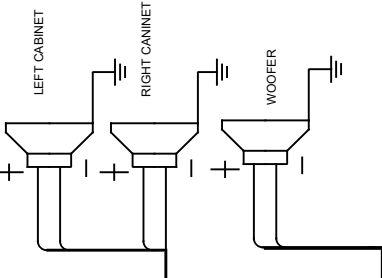

LEFT CABINET

RIGHT CABINET

WOOFER

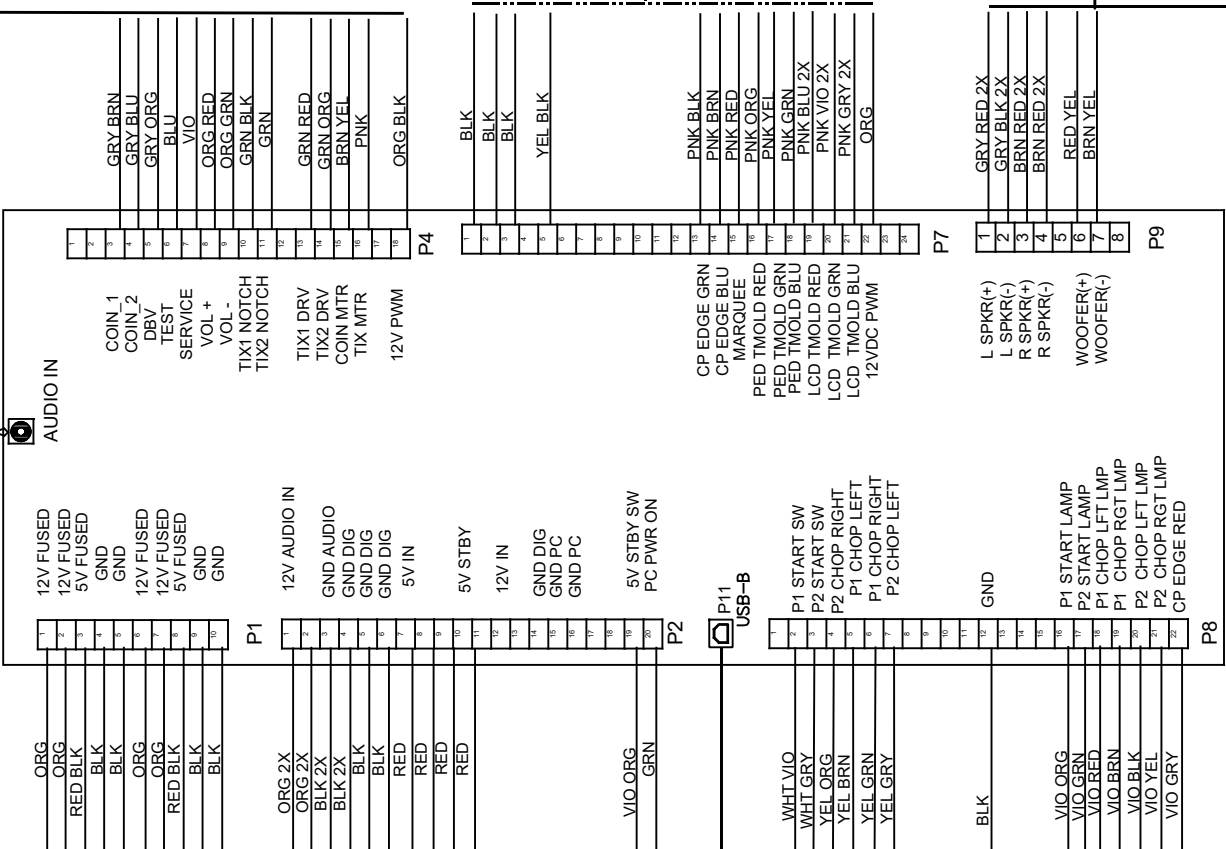

Choppy Wood™

Technical Support

For an authorized distributor near you, check the Raw Thrills website at www.rawthrills.com

TECHNICAL SUPPORT

PHONE 1-800-753-2513 (Betson's Raw Thrills Technical Support Hotline)

FAX 1-201-438-5019

EMAIL rtsupport@betson.com

